



AutoGate, Inc.

## Installation & Operation Manual

Vertical Pivot *Shield*® Crash Systems

ASTM F2656 M30-P1, M50-1

**M30 Models: VPCB-M30 & VPCM-M30SF**

**M50 Model: VPCB-M50**

AG# \_\_\_\_\_

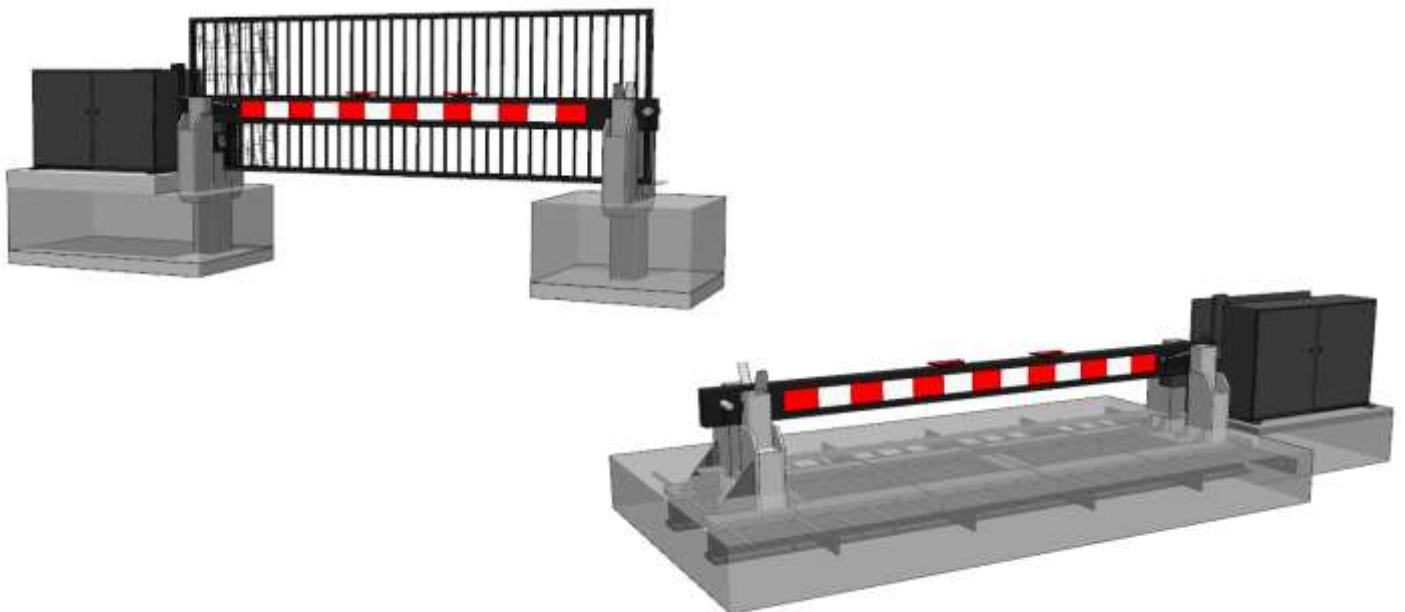

7306 Driver Road, P.O. Box 50, Berlin Heights, OH 44814

PH: 1.800.944.4283 - FAX: 419.588.3514 - [www.AutoGate.com](http://www.AutoGate.com)



# Shield® Crash Barrier Systems

## INSTALLATION MANUAL

- **THIS PRODUCT IS TO BE INSTALLED AND SERVICED BY AN EXPERIENCED TRAINED EXCAVATION AND GATE SYSTEMS TECHNICIAN ONLY**
- This model is used for vehicular traffic **ONLY** and not intended for pedestrian use.
- The VPCB-M30 (Standard Foundation), VPCB-M30SF (Shallow Foundation) and VPCB-M50 are certified to the ASTM F2656-07 Standard. They are rated at M30-P1 and M50-P1. They have been designed and tested to stop a medium-duty truck weighing 15, 000Lbs. traveling at 30 & 50 mph and arrest the vehicle within 3.3 ft. (1 meter) of penetrating the barrier arm.

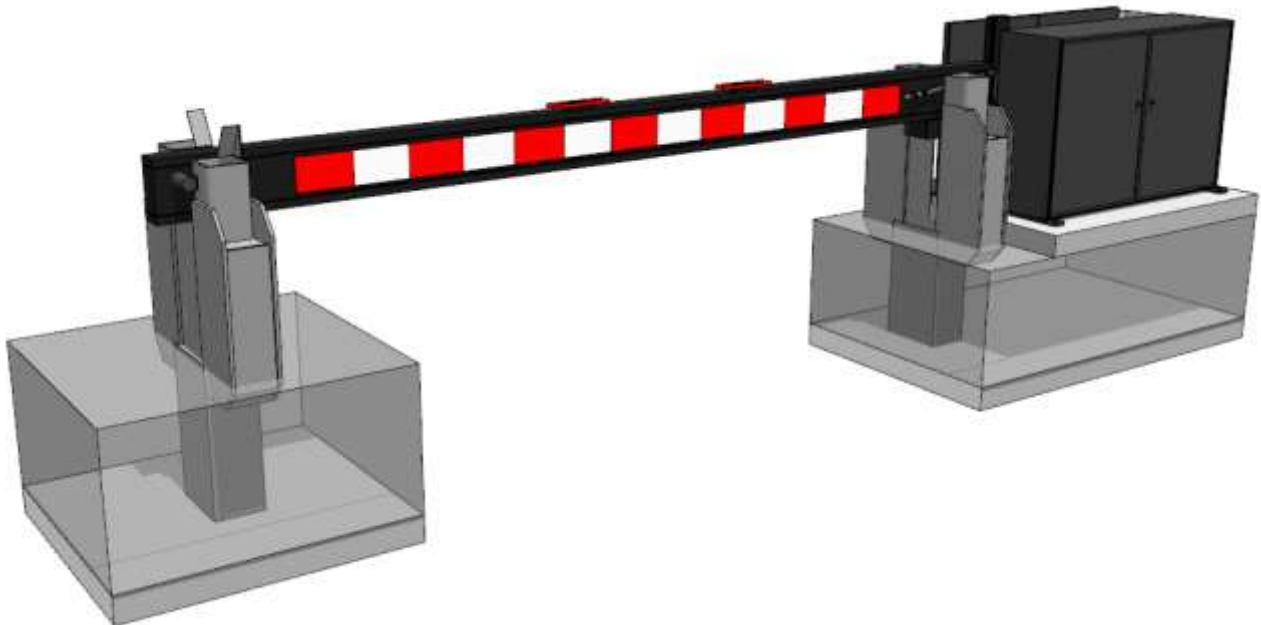

**MODELS VPCB-M30, VPCB-M30SF & VPCB-M50**

# Table of Contents

Safety & Helpful Information	4-5
Orientation	6
Standard Specifications	7
Operator Details	8
Operator Glossary / Terms	9
Basic Components of A SHIELD CRASH System Foundation	10
Left & Right Typical Pad Layouts	11
Typical Loop Configuration	12
Site Planning	13-15
Site Preparation	16
Bolster Planning & Installation	17-20
Receiving, Unloading, & Handling Your System	21
Preparation, Attaching the gate & Operator Installation	22-27
Gate Guards, Signs & Reflective Tape	28-29
Operator Electrical, Grounding & Battery	30-31
Genesis Control Board	32
Operator Wiring Diagram	33
Safety & Helpful Information	34-35
Genesis Board Connections	36-40
Entrapment Protection Device Functional Characteristics	41
Genesis Board Programming	42-48
Genesis Frequently Asked Questions (FAQ'S)	49-50
Troubleshooting the GENESIS Board	51
Accessory Components	52
Maintenance	53-57
End User / Installer Check-off List	58-60

## SAFETY & HELPFUL INFORMATION

### IMPORTANT SAFETY INFORMATION FOR INSTALLERS AND OWNERS

Read all of this manual and all product safety information prior to installation. AutoGate Shield CRASH Barrier M30 & M50 systems operators (hereafter referenced as Shield or VPCB (Vertical Pivot Crash Barrier)) move the fortified crash barrier Drop arm/gate with high force and can cause serious injury and death! All Shield systems have fortified barrier arms. The terms barrier arm, drop arm and gate are synonymous in this manual as some Shield systems are and can be ordered with a full size gate directly fabricated to the barrier arm. Start the operator only when the travel path of the Shield arm is unobstructed and clear from making any contact with personnel or any equipment. Make sure the Shield systems are installed to reduce the risks of entrapment and are installed to comply with all safety standards, local and federal regulations, and all manufacturer instructions.

Understand that you as the site designer, installer, maintenance crew, or owner/user must consider the risks associated with the Shield operators. Be sure to take responsibility, read, and follow the Important Safety Information in this manual and review all the literature that accompanies the product prior to installation.

Proper design is important in your system layout and installation. Entrapment protection devices must be used at all points where injury or property damage may occur. For protection from injury to persons, use Photo Electric Eye(s) and/or optional Pressure Sensing Edge on the leading edge of the gate and on the operator housing. Loops (Vehicle Detectors) should be installed in front of and behind the gate to provide a reverse signal or stop signal to the gate operator. All entrapment protection and reversing devices should be tested and inspected weekly. If any device appears to not operate correctly, the unit should be disabled until repair can be made by a properly trained and experienced service company.



As the system installer, you must advise your customer on the correct usage of the barrier operator system components. In providing the service of designer or installer of the operator and gate system, you are responsible for proper training of the customer as well as for the proper safe operation. All precautions to eliminate hazards MUST be taken before the system can be put into operation. You MUST advise and warn your customer of any hazards that remain. We highly recommend if they choose not to install any of the entrapment protection and recommended reversing devices to not put the system into operation until safety and risk concerns have been resolved and documented.

- Check the National, State & Local Building and Fire Codes BEFORE installation as well as the project plans and specifications.
- Pedestrians must use a separate entrance/exit and never the vehicular entrance/exit gate.
- This product operates under high force and serious injury and death can occur. AutoGate highly recommends and strongly advises the use an proper installation of external entrapment protection devices.
- If you did not order a Reversing Edge (for along the bottom rail of your gate or operator housing), or an Photo Electric Eye(s) (Reversing Beam), you will NOT be in compliance with the intent and practices of UL 325 Code. Consult your dealer for additional information.
- NEVER activate the gate from where visibility of the gate cannot be seen. Anyone operating the gate should always operate it in direct line of site and in a safe manner.
- NEVER allow children or anyone to play on or around the gate at any time.
- DO NOT attach anything to the gate over 4 pounds total weight or 4 square feet without consulting AutoGate for approval and balancing instructions. The gate must remain balanced to ensure safe and reliable operation.

## SECTION 1 — SAFETY

### SAFETY SIGN AND SYMBOL REVIEW

When you see these Safety Symbols and Signal Words on the following pages, they will alert you to the possibility of serious injury or death if you do not comply with the warnings. The hazard may be something mechanical or from electric shock. Read the warnings carefully to avoid personal injury, they will alert you to the possibility of damage to your drop arm/gate and/or the gate operator if you do not comply with the cautionary statements that accompany it. Read them carefully.

	WARNING
	ELECTRICAL
	CAUTION
	NOTE

### IMPORTANT NOTE:

- **BEFORE** attempting to install, operate or maintain the operator, you must read and fully understand this manual and follow all instructions.
- **DO NOT** attempt to repair or service your gate operator unless you are experienced service technician or a factory trained Service Technician.



**WARNING:** This product can expose you to chemicals including lead, which are known to the State of California to cause cancer or birth defects or other reproductive harm. For more information go to [www.P65Warnings.ca.gov](http://www.P65Warnings.ca.gov)

## REDUCE RISK

- Be aware of and follow the safety standards of the Occupational Safety and Health Administration (OSHA), as well as any applicable Federal, State, Local Project Specification and Industry Standards or Procedures.
- Only experienced personnel are to install, operate and maintain the equipment. Serious injury or equipment damage can occur if installed or operated by untrained personnel. Installers of the equipment must follow the specific instructions and safety precautions located in this manual.
- At NO time should the Drop arm/gate be modified in any way. Under NO circumstances should you drill into the Drop arm/gate Housing with prior written authorization from AutoGate.
- Do not add any additional weight to the Drop arm/gate or applicable gate panel without first contacting AutoGate. This can affect the balancing and operation of the system.
- Always keep people, equipment and objects away from all moving parts and entrapment/pinch points of the system. **NO PERSON OR OBJECT SHOULD CROSS THE PATH OF THE MOVING GATE.**
- Test the operator monthly. The drop arm/gate **MUST** reverse on contact with a rigid object or stop when an object activates the non-contact sensors or contact sensor. After adjusting the force or the limit of travel, reset the operator. Failure to adjust and reset the operator properly can increase the risk of injury or death. Never use the gear motor release/engage lever when the gate is moving and not powered down.
- This gate system is for vehicles only. **PEDESTRIANS MUST USE A SEPARATE ENTRANCE!**

### SAVE THESE INSTRUCTIONS

- The Shield can produce high levels of force. It is very important that all installers and designers are fully aware of potential hazards that exist with incorrectly installed or designed systems. The internal safety capabilities of a gate operator system are not enough to remove the risk of injury. The operator is only one part of a properly installed system which when combined with correctly installed reversing devices, will yield a system that will not only provide convenience and security, but will be safer and minimize risk of injury. These instructions are to make you aware of potential areas that are of a safety concern. Disregarding any of the following may result in **Serious Injury or Death!**

## ORIENTATION

### ORIENTATION

The *Shield*® VPCB (Vertical Pivot Crash Barrier) systems have many features that make it effective, reliable, and easy to use, and some of these important features are summarized in this manual. Note that not all systems are identical as width, gate panel implementation, finish, accessories such as lights, and other auxiliary component options vary order to order. The most notable visual difference in crash models are the foundation and bolster design. Drop arm only or those with gates are common and optional for all models. They can be outfitted with full gate panels are typically comprised of chain link, ornamental, industrial, high-security and anti-climb fencing to add anti-personnel entry along with your forced entry denial.

The *Shield*® M30 is available in two different foundation depths. Model VPCB-M30 is our standard foundation and has a depth of 54". Model VPCB-M30-SF is our Shallow Foundation and has a depth of only 20". The Shallow Foundation is ideal for locations with utilities that cannot be disturbed, high water tables, and locations that cannot otherwise support our standard foundation depth. Our VPCB-M50 has one foundation size and a depth of 66".



**Model VPCB-M30 Standard Foundation (54" depth) with full gate panel**

**Model VPCB-M30 Standard Foundation (54" depth) with Drop arm only**

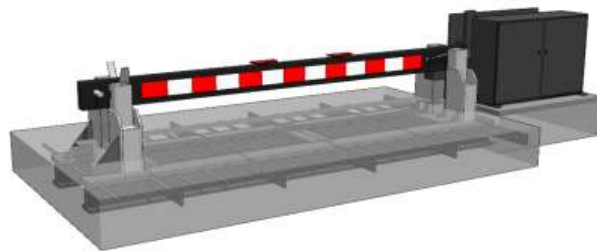
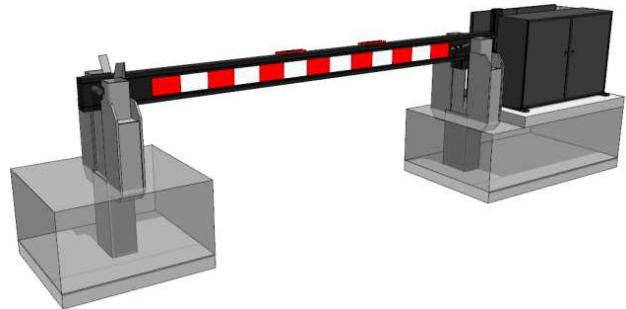

**Model VPCB-M30-SF Shallow Foundation (20" depth) with Drop arm only**

**Model VPCB-M50 (shown with full gate panel) Standard Foundation 66"**

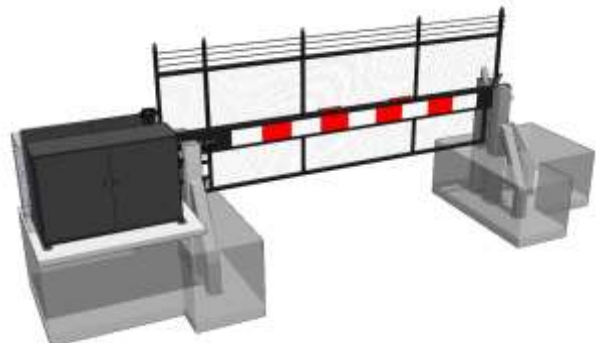



## VERTICAL PIVOT CRASH BARRIER SYSTEMS (VPCB)

- ◆ MODEL VPCB-M30 (STD. FOUNDATION)
  - ◆ VPCB-M30-SF (SHALLOW FOUNDATION)
  - ◆ VPCB-M50 (STD. FOUNDATION)
- ### PRODUCT SPECIFICATIONS

#### General Information

**Ratings:** ASTM F2656-07 Standard. M30/P1 & M50/P1 and listed on the DoD Anti-Ram Vehicle Barrier List

**Power Supply Options:** 120VAC—Single Phase, 20 Amp Service. 240VAC—Single Phase, 10 Amp Service.

**Batteries & Charging System:** Built-in Battery Backup. Two 12v Batteries Required (Field Supplied). **Recommended Batteries:** Group 24, Sealed Marine Starting

**Arm Limit/Position Sensor (LPS):** Self aware of gate position at all times. Open and Closed Limit Positions.

**Open/Closing Speed:** 12-14 seconds Std.

**Shipping Weight:** Typical (Includes Drop arm/gate system and Bolsters) **Gate & Operator weight:** 2000 lbs.

#### Bolsters:

VPCB-M30: 3,000 lbs.

VPCB-M30SF: 5,200 lbs.

VPCB-M50: 5,300 lbs.

**Warranty:** Industrial/Commercial (3 years) from date of shipment on manufactured components workmanship. Purchased components and accessories are covered under their respective warranties. (See full warranty for details)

**Optional Accessories:** Loop Detectors, Gear Motor Heater, Extreme Cold Package, MUTCD Reflective Tape, LED Warning lights, Audible Devices, and Emergency Access Systems (SOS, Opticom, Click to Enter, Key Box/Switch, etc.)

**Transport Maintenance Pin (T/M):** used for transport, maintenance to negate movement of Drop arm/gate panel)

#### Motor & Drive System

**RAD (Right Angle Drive):** 1/2 HP, Gear Type, Right Angle Locking Worm Drive, Muti Temp Synthetic Lube, Equipped with disengage lever for Manual Operation.

Multi Belt/High torque dual reduction system, Counter Balanced for smooth operation.

#### Operator

**Construction:** Frame - 2" Sq., 11 Ga. (.120). Mounting pads—304 SS. Skins - 18 Ga. Galvanneal.

**Gate Mounting Hardware:** 304 Stainless Steel

**Operator size:** 68" Length, 52" Height, 39" Width

**Paint:** Standard Color - Black, powder coated. Spray applied colors are Commercial Coating 2-part High Solids Polyurethane. **Standard Spray Colors:** White, Brown, Green, and Gray. Custom colors available.

#### Genesis™ Control Board

Solid State coated programmable control board in an electrical enclosure (Tested to -40° F).

**Security Breach Protection:** Built in 24V brake when A/C or battery is present. Optional internal locking Solenoid mechanism.

Built in sensor for real time barrier position.

**Monitored Inputs:** Open - 2 inputs, Close - 2 inputs and an additional (2) programmable inputs for Open or Close.

**Programmable Inputs, Outputs, & Relays:** The Genesis board has 2 programmable inputs, 2 programmable outputs, and 2 built in relays for configuration and integration.

**Control Wiring:** 16 & 18 Ga. Single conductor. Copper with electronic compression terminals tin-plated for max corrosion prevention. Non-AutoGate components, accessories, and access control is per individual manufacturer instruction. Contact AutoGate with questions.

**Delayed Closing:** Programmable from 0 - 90 seconds.

**Preemptive outputs:** 1 - 5 seconds before gate moves.

#### Arm & Gate Construction

Systems are available in barrier arm only for forced vehicular entry denial and with a full gate panel fabricated to the barrier arm for anti-personnel capabilities.

**Available clear open lengths:** **M30:** 19' with barrier arm only and 17' with gate panel fabricated to drop arm/gate. **M50:** 17' with barrier arm only and 15' with gate panel fabricated to drop arm/gate.

**Barrier Arm Construction:** 6063 3/16" channel and 5052 3/16" plate. **Locking Pins:** 4140 Steel. **Gate Construction:** 2 1/2" Sq., 7 Ga. (.187) Aluminum Tubing.

**Gate Max Length:** 19' Overall length (17' clear open section).

**Gate Heights:** 6' - 9' from pad grade. Consult factory for gates over 8' high as they require special crating and freight arrangements.

**Picket Construction:** Aluminum—3/4" Sq. 1/8" wall is standard. Note: Contact factory for special sizes, spacing, and custom materials.

**Chain Link Fabric:** Steel 9 Ga. Alum Fabric is standard on larger gates (Vinyl coated fabric available).

**Drop Arm & Gate Paint:** Spray applied colors are Commercial Coating 2-part High Solids Polyurethane. **Standard Spray Colors:** Black, White, Brown, Green, and Gray. Custom colors available.

## OPERATOR DETAILS

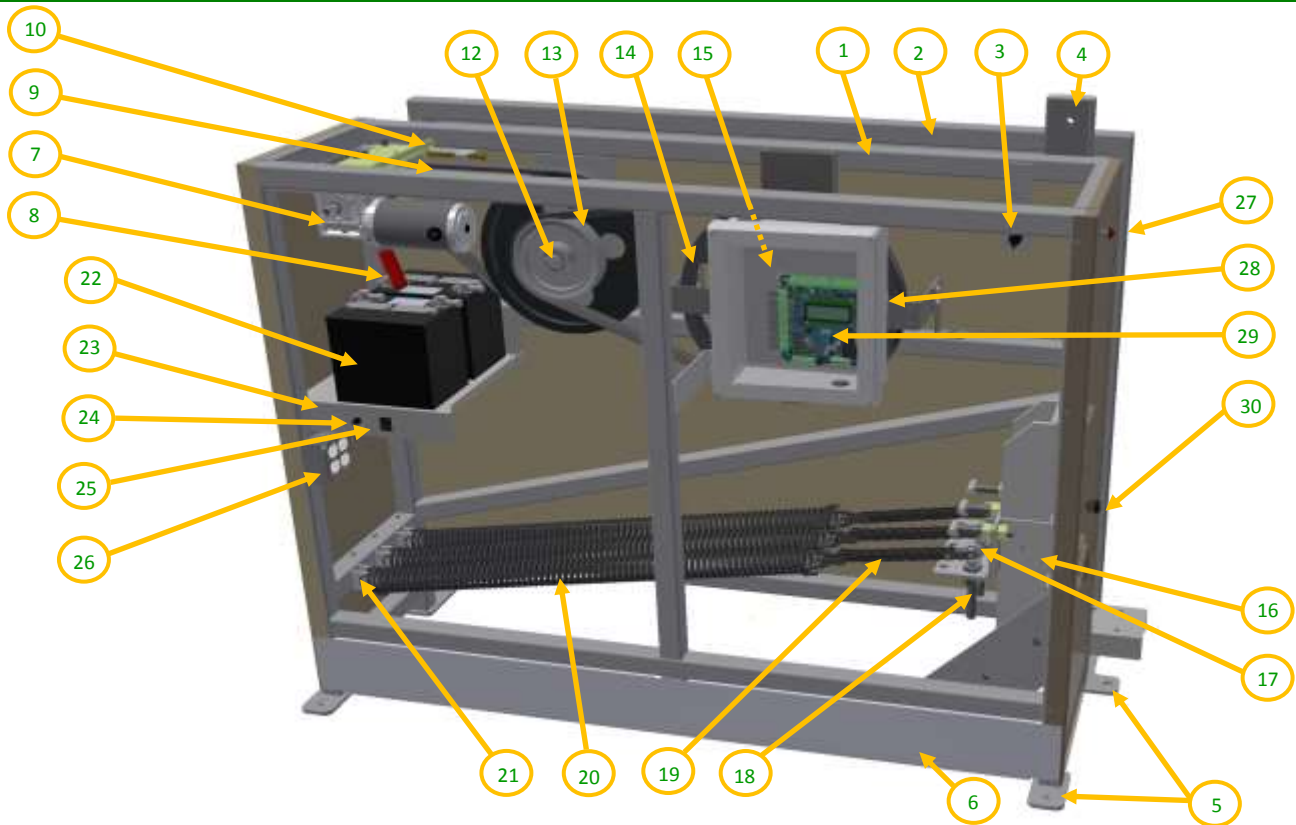

1	OPERATOR FRAME	Main operator frame, 2" sq. steel tube construction
2	THROAT	Area between the operator and false panel where the gate opens up
3	TRANSPORT/MAINTENANCE PIN (T/M)	Used for locking the arm in place with or without the gate attached
4	OPERATOR ARM	Main 2" x 4" steel tube where the gate attaches
5	STAINLESS STEEL FOOTPADS	No messy rusty footpads
6	KICK PANEL	Prevents access under the operator and debris out
7	24VDC 90° RIGHT ANGLE DRIVE MOTOR (RAD)	1/2hp Gear motor drive to ensure safe and smooth operation
8	MANUAL OPERATION REALEASE LEVER	Disengages the coupler and allows the gate to be raised by hand
9	MOTOR DRIVE BELTS	(3) High quality "A" Section cogged belts...
10	MOTOR DRIVE BELT TENSIONER	One shown, total of two
11	GATE BELT TENSIONER (Not shown, behind #12)	Allows you to tighten the belts <b>(Not shown behind the Drive Pulley)</b>
12	INTERMEADITE DRIVE PULLIES	Provides high torque to move the gate
13	GATE DRIVE BELTS	(2) High quality V-belts to move the gate
14	MAIN GATE DRIVE PULLEY	Provides high torque to move the gate
15	LIMIT/POSITION SENSOR (LPS) (behind #28)	Digital Sensor that sets the open and close locations of the gate
16	SLIDE ASSEMBLY	Adjust the balancing up or down on the threaded rod (not pictured)*
17	T-BOLT ASSEMBLY	Fine tuning of the balancing
18	CHAIN TENSIONING BOLT ASSEMBLY	Roller chain attaches here
19	#80 ROLLER CHAIN	Connects the springs to the Chain tension Bolt
20	SPRINGS (Qty. will vary on gate size and weight)	Depending on gate size & weight, you can have 2 to 8 springs
21	REAR SPRING BARS	Attaches the springs, Qty. will vary on the # of springs
22	BATTERIES ((2) required, not supplied)	Min. 7Ah batteries, recommend Group 24 100Amp Marine Starting
23	BATTERY TRAY/POWER SUPPLY (Under Battery tray)	Main Power Supply is mounted under the Battery Tray
24	3Amp AC Fuse	AC Supply fuse
25	AC/DC MAIN ON/OFF SWITCH	Turns on both the AC and DC power in one switch
26	INCOMING AC VOLTAGE JUNCTION BOX	Normally 120Vac, 240Vac compatible
27	FAULT LIGHT	Three flash modes: 1. Fault, 2: DC Power issue, 3: AC power issue
28	CONTROL BOX	Houses the Genesis control board and other accessory items
29	GENESIS CONTROL BOARD	State of the art control board with 4-line digital display
30	UL325 SIREN	Will be activate upon an UL fault
	* See Balancing Instructions for Slide details	



## SECTION 2 — TERMS

### GLOSSARY OF IMPORTANT TERMS

Operator	The mechanical device designed to open and close (raise and lower) the Drop arm/gate.
Operator Arm	The steel tubing member of the operator the Drop arm/gate is bolted to and lifts the Drop arm/gate.
Slide Assembly	An adjustable mechanism located on the operator arm that the extension springs attach to and by adjusting up and or down adds or subtracts tension to balance the operation of opening and closing of the Drop arm/gate.
Hand	The orientation or direction in which a Drop arm/gate assembly faces. AutoGate determines the “Hand” of the operator by standing on the Private side of the gate entrance and facing the public side.
False Panel	The exterior covering of the operator that typically faces the public side of the installation and provides protection from the moving Drop arm/gate.
Transport/Maintenance Pin (T/M)	Used to secure the Operator Arm when there is no Drop arm/gate attached. Also is used as a safety lock open/closed device during installation and service work.
RAD (Right Angle Drive)	½ HP Motor Drive utilizing locking worm gear technology. The motor shaft and output drive shaft are oriented at 90° from each other. This type of drive provides for smoother operation throughout the gate movement cycle and is not back drivable.
Manual Operation Release Lever	Used to disengage the Right Angle Drive (RAD) from the belt drive system to allow manual opening or closing of the Drop arm/gate.
LPS (Limit/Position Sensor)	An electronic position sensor mounted on the main pulley drive shaft that provides Drop arm/gate position feedback to the control board. This component provides two separate features: <ol style="list-style-type: none"> <li>1. Type “A” inherent entrapment protection which safeguards against obstructions that may block and stop the gate travel.</li> <li>2. Provides “open” &amp; “close” limit positions</li> </ol>
Genesis Control Board	The main circuit board that processes the inputs and outputs to control the overall operation of the SHIELD system.
Kick Panel	The panel under the doors to prevent anything from getting under the operator including hands, feet & rodents.
Gate Guard	The guard that protects pedestrians from accessing Drop arm/gate

## BASIC COMPONENTS OF A SHIELD CRASH SYSTEM FOUNDATION

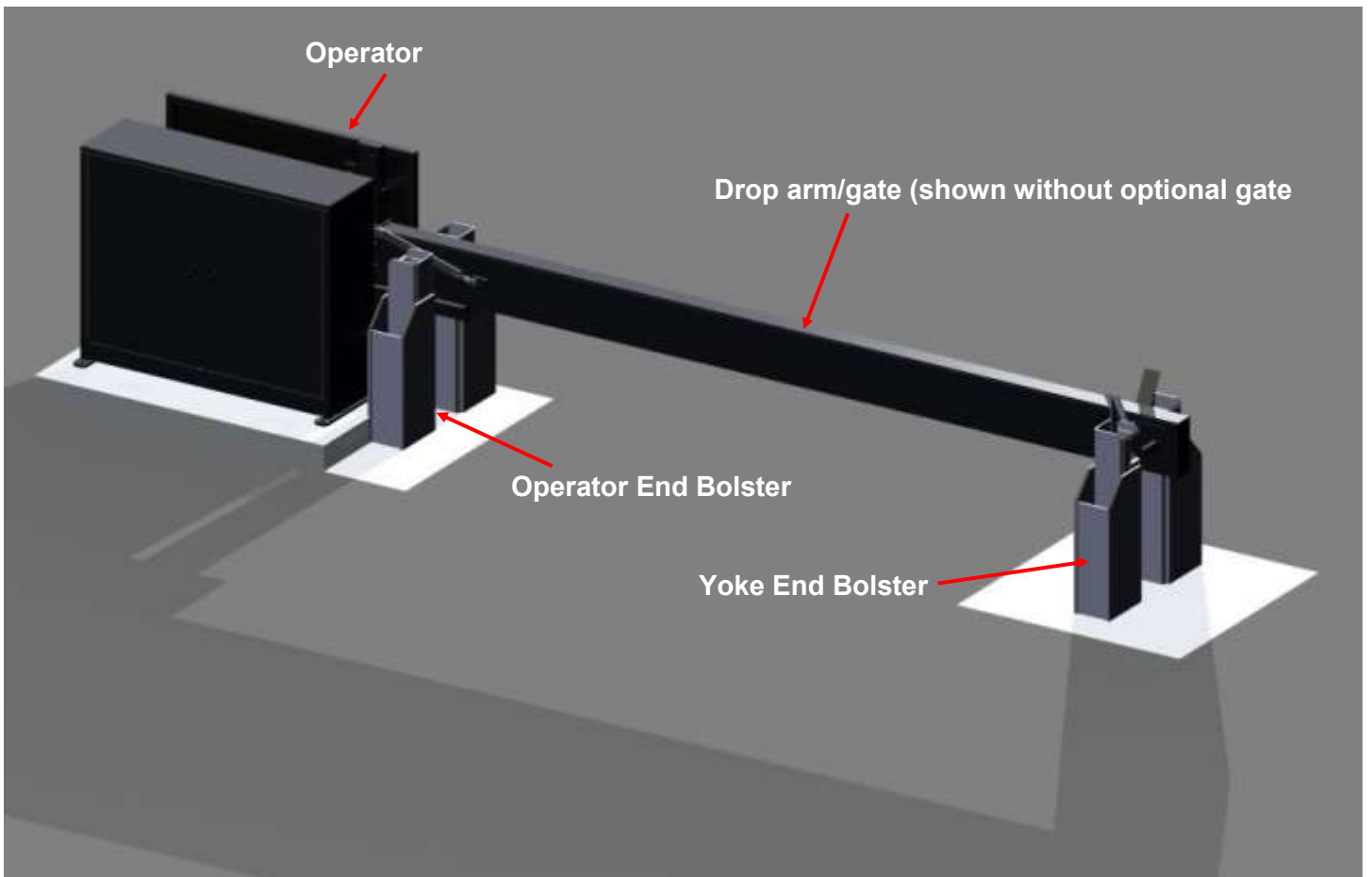
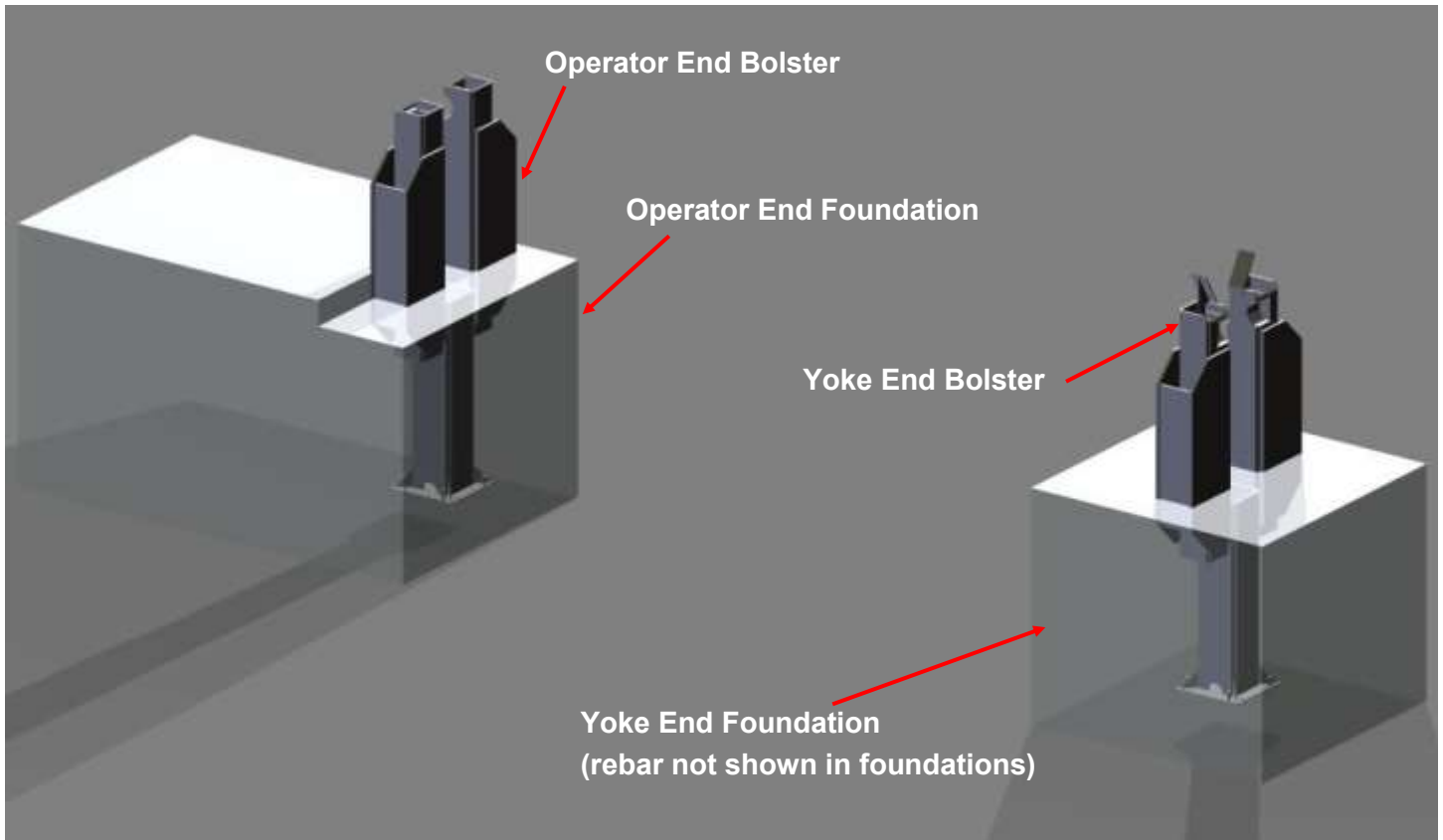

**LEFT AND RIGHT HAND "TYPICAL"**

**LEFTHAND OPERATOR**

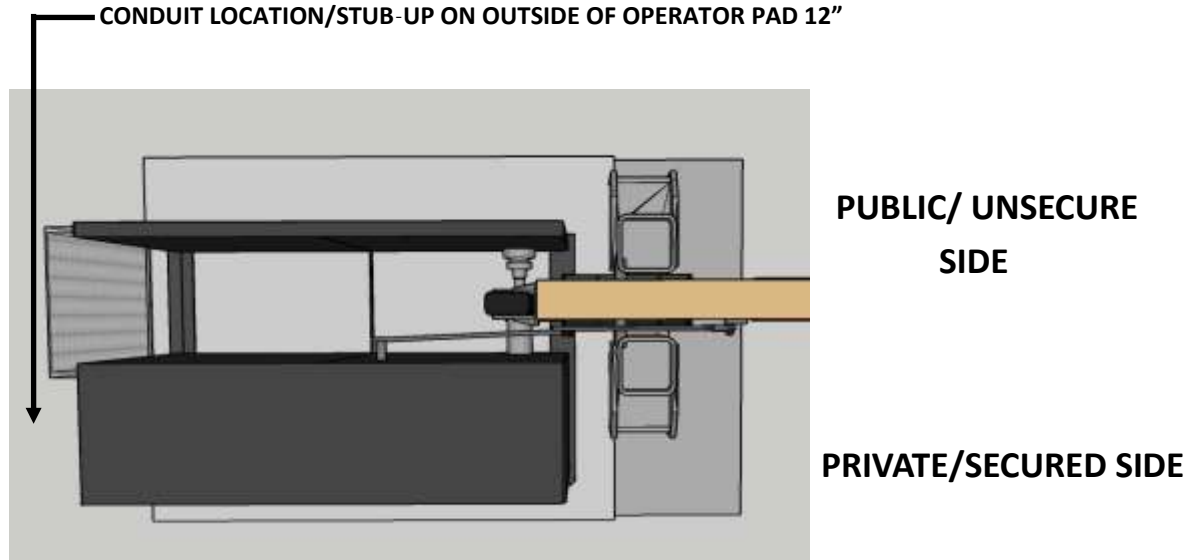

<b>NOTES:</b>	◆ 120Vac, Minimum 20Amp Circuit	◆ Free Exit Loop(s)
	◆ "Entrance" Keypad/Reader	◆ Office Communication
	◆ "Exit" Keypad/Reader	◆ Reversing Beam
	◆ Reversing Loop(s)	◆ Optional
1) Pad Dimensions can vary per site		
2) Leave at least 3" between Anchors and edge of pad		
3) All pads must be level and below local frost line		

**RIGHTHAND OPERATOR**

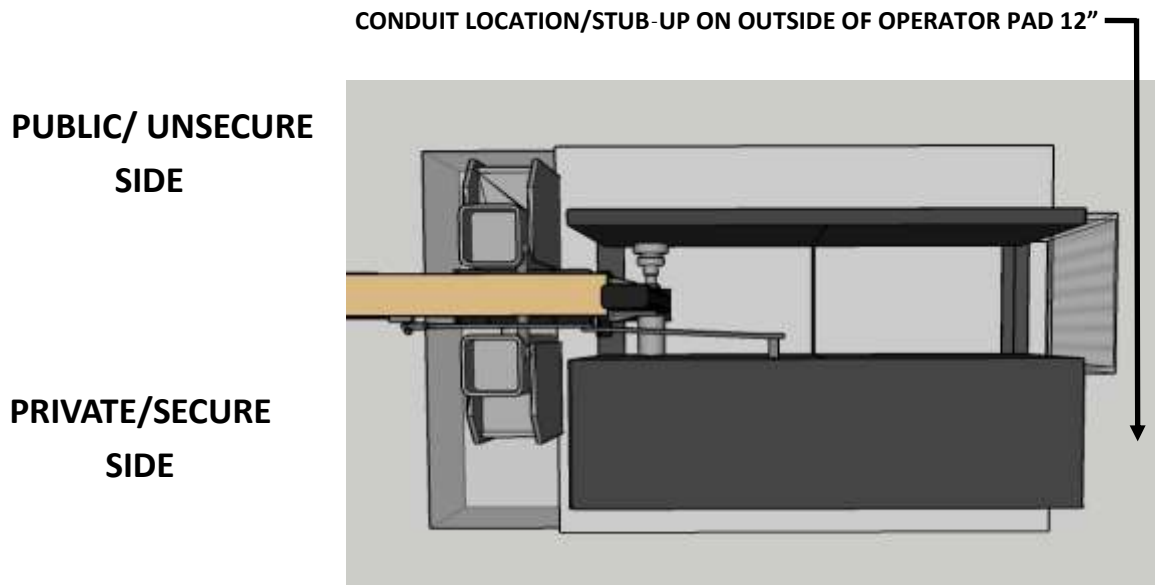

## SHIELD & LOOPS

### VEHICLE LOOP INSTALLATION AND PERFORMANCE

Ground vehicle sensing loops are very common to gate sites. They are used for the detection of vehicles which then triggers the gate to do a specific action. Proper installation and placement is critical. If you purchased Pre-formed Loops carefully follow the enclosed installation instructions and use the diagram below for the proper placement of the ground loops. If you are constructing the loops on-site, be certain to use D.O.T. approved materials and methods. Each site may have several loops to provide a variety of functions for vehicle detection and control. Below is a simple example of a loop layout.

Test the function of the loops thoroughly by using vehicles once installed to verify correct operation.

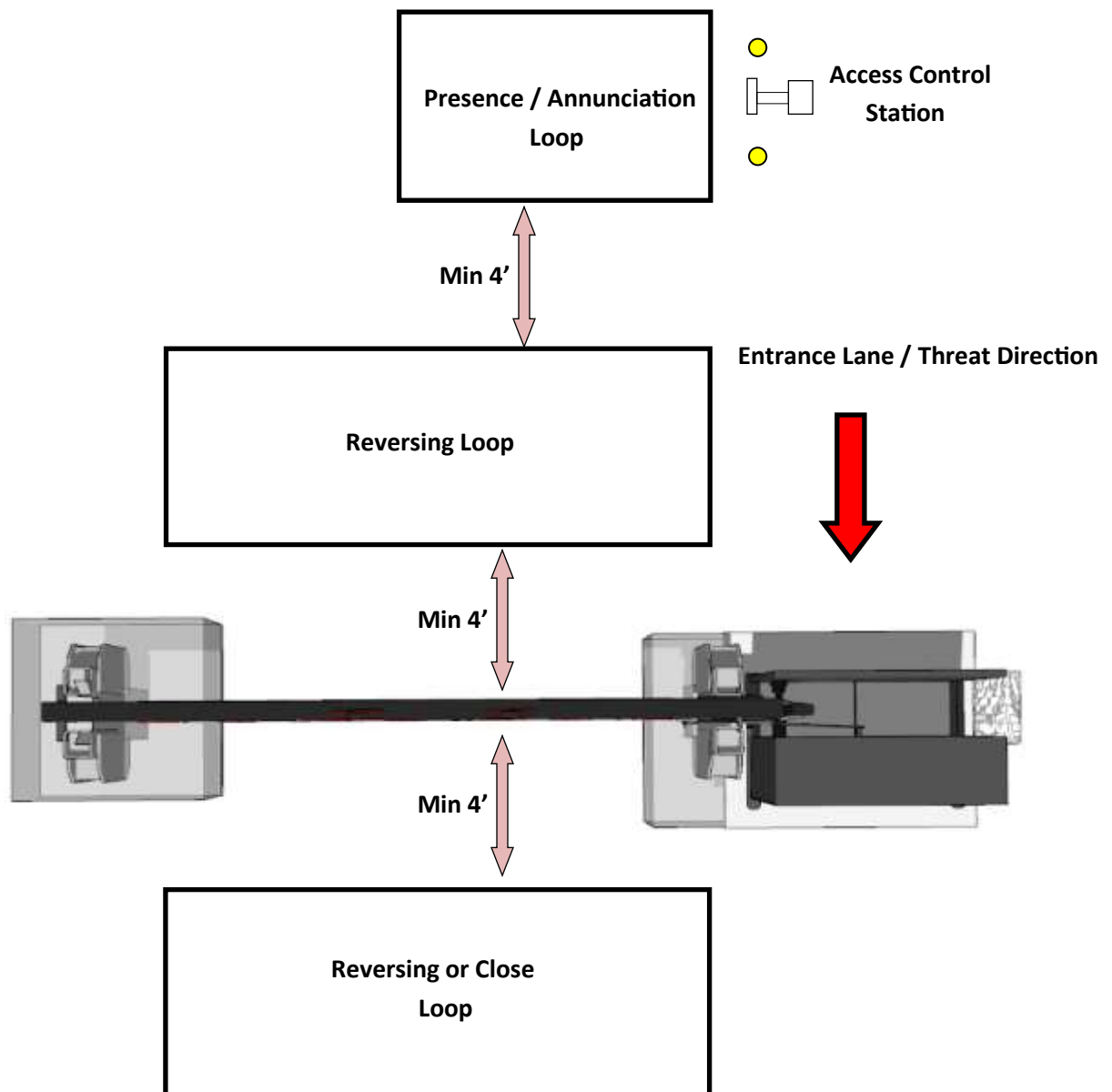

# SITE PLANNING

## SITE PREPARATION & PLANNING

When you ordered your system you specified either a right-hand or left-hand system. See Pages 12-18 for examples of a LEFTHAND and RIGHTHAND pad and operator layouts. From these illustrations and your specific site layout, you must decide exactly where operator and crash barrier Bolsters will be finally positioned. You also need to determine the trenching and running of conduit around the access control point, back to the operator for power and control connectivity.

Determine if there are any accessory components to be installed with your system such as traffic lights, in-ground loops, access control stations, etc. and factor them into your site layout and installation plan. Inspect the site and verify there are no underground utilities, overhead wires, or other obstructions that can effect your installation and use. If possible, keep routine foot traffic away from the system to reduce the chance of pedestrian or site personnel coming in contact with a moving barrier system. A separate pedestrian gate or turnstile is highly recommended so as to discourage the use of the barrier system by anything other than vehicular traffic. This evaluation and planning, along with coordination with electricians and other on-site

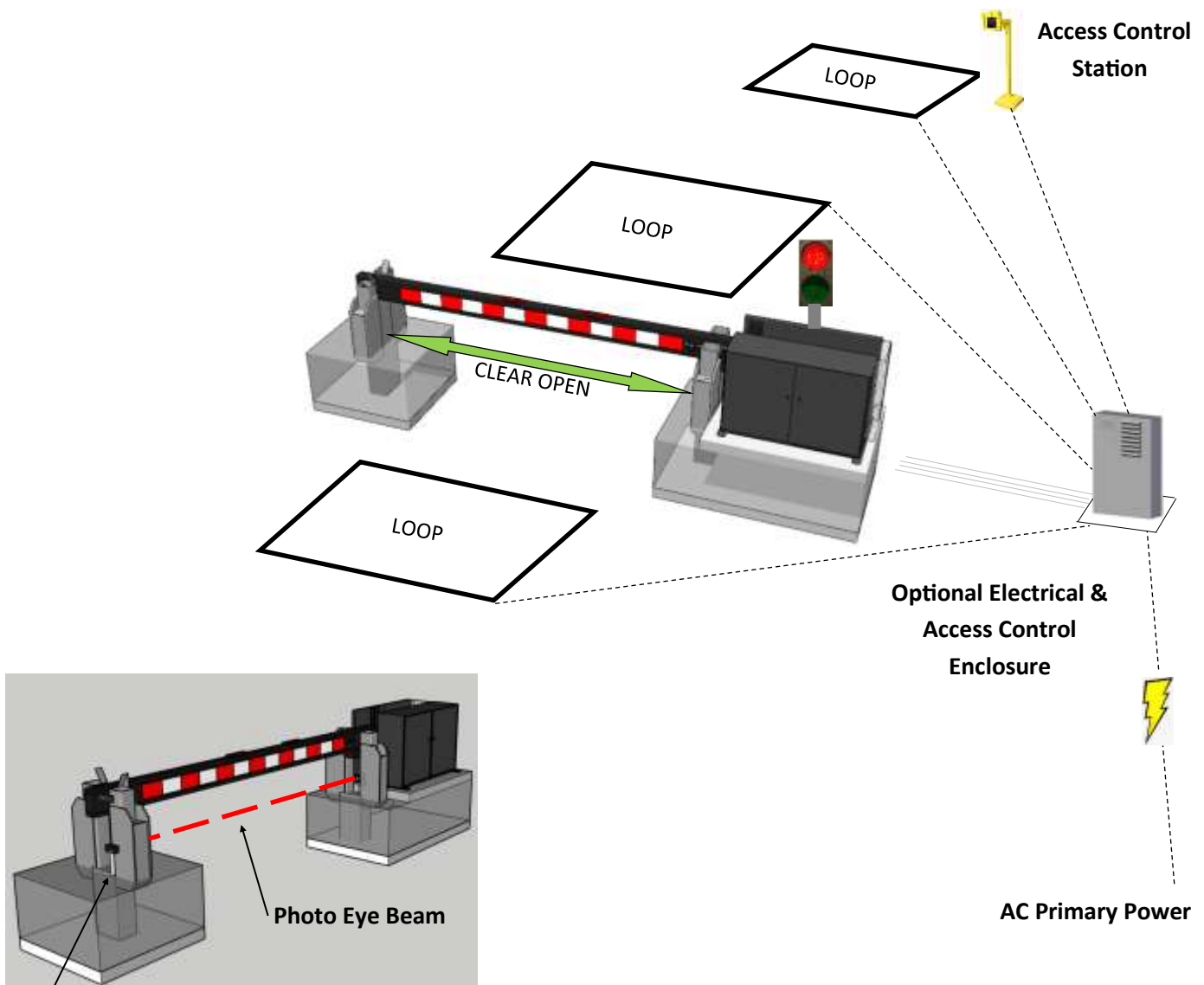

Note: Photo Eye Requires power at Yoke End

## SITE PLANNING

### Foundation Planning

The following chart will detail several important items required in a basic installation. Every site will be different and needs to be reviewed on a job by job basis.

Heavy Duty Fork lift with side shift if possible, Gradall, or alternative	For lifting the Bolster and later for lifting the operator and Drop arm/gate
Backhoe or alternative	For excavating the foundation and any needed trenching
Hammer drill, including 1/2" and 3/4" bits x 12" long	For drilling and securing expansion/anchor bolts to pad and operator
Hand tools, including hammer, screwdrivers (flat & Phillips), 1/2" drive socket set, open end wrench set	For component installation
Lifting straps/slings or chains rated to safely handle the weight of the system (See Spec sheet for weights, page 8)	For off-loading from delivery transport, moving to installation area, lowering bolster into excavated area, and landing the operator/Drop arm/gate on the pad
Theodolite or equivalent	For trench layout accuracy, leveling the bolster accurately and positioning within tolerances specified
Concrete finishing tools (trowels, screeds, brooms, etc.)	For concrete finishing
Soil Tamper/Concrete vibrator	For tamping the soil to correct compression and removing entrapped air in concrete
Concrete	4,000 psi with non-shrinking additives

Typical Foundation: VPCB-M30 shown (see your order specific drawings for project specific details)

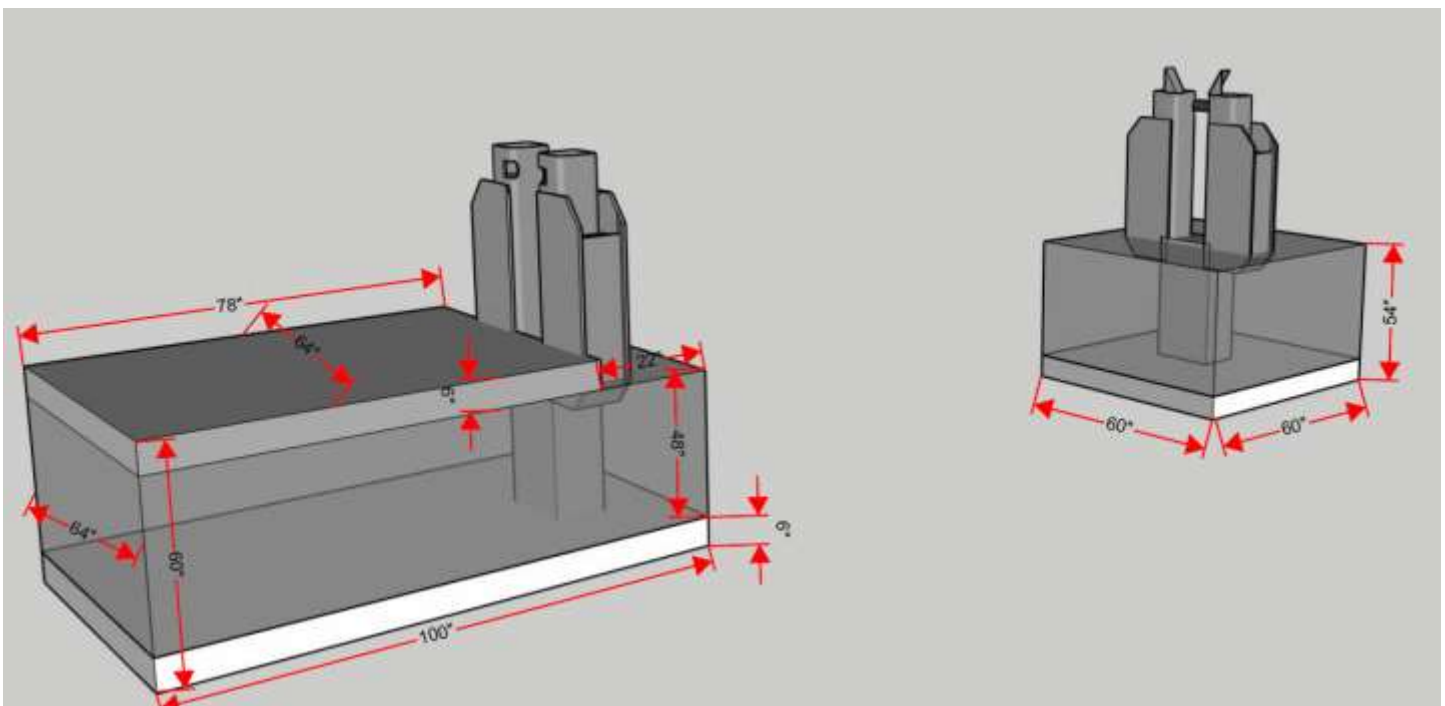

# SITE PLANNING

Typical Foundation: VPCB-M30-SF shown below (see your order specific drawings for project specific details)

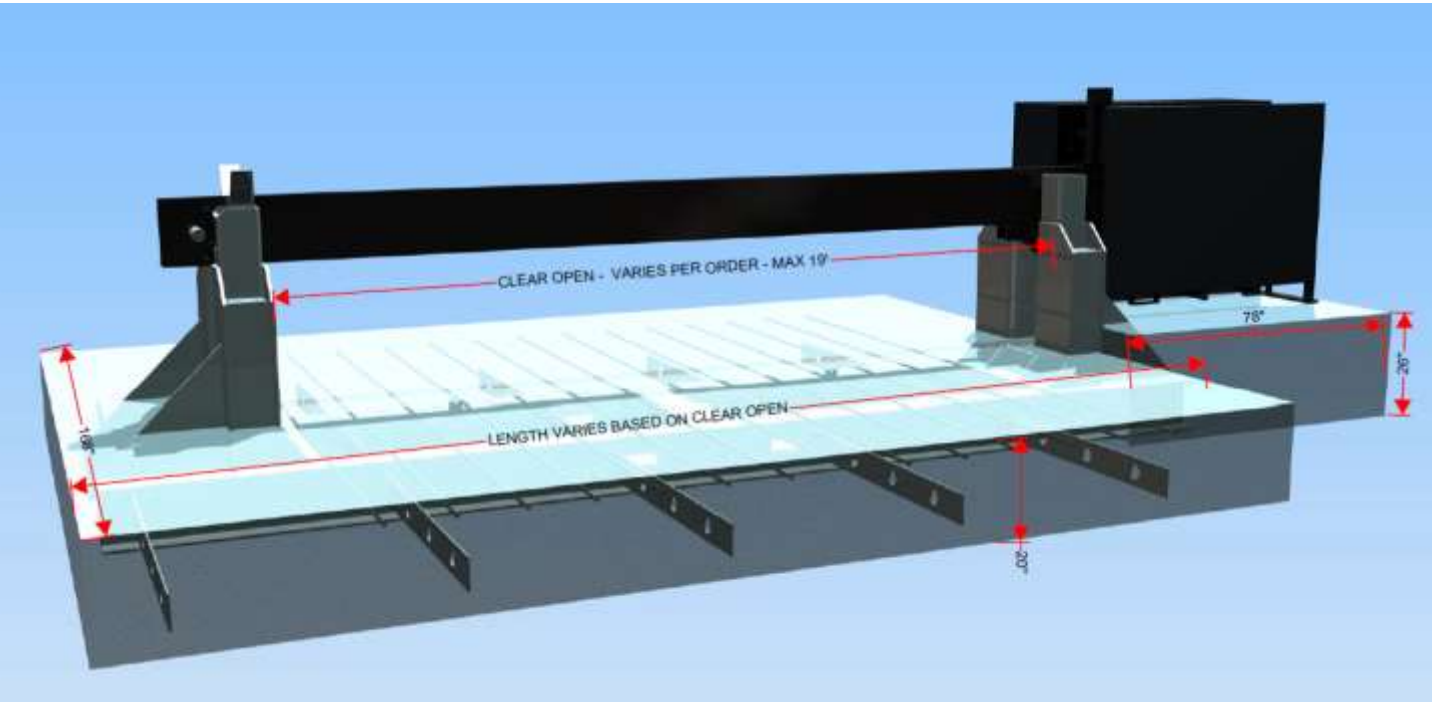

Typical Foundation: VPCB-M50 shown below

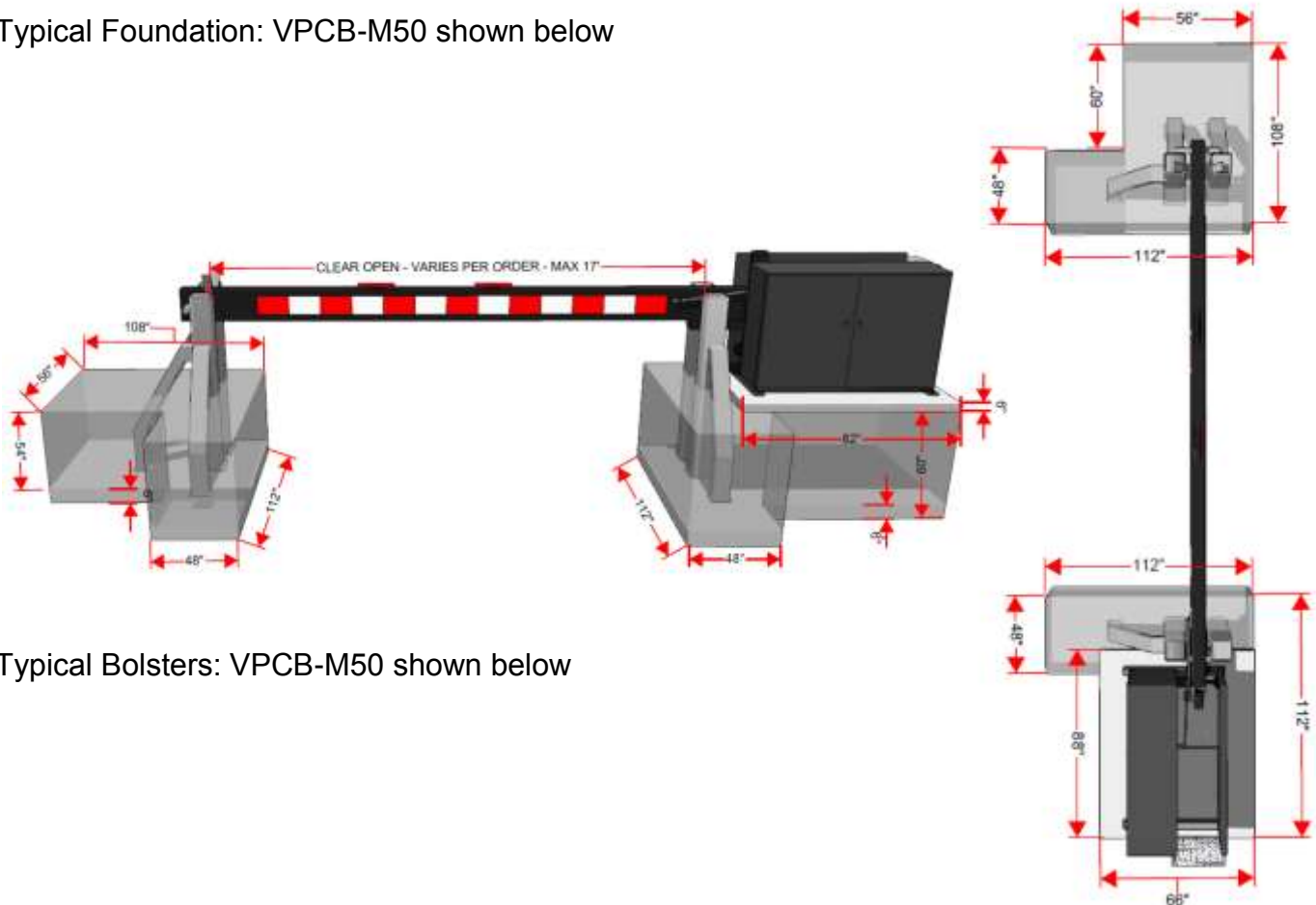

Typical Bolsters: VPCB-M50 shown below

## SITE PREPERATION

For efficiency, you may want to excavate for other components and site needs concurrently with the foundation excavation, such as but not limited to:

- Trench for the conduits for power lines running to the operator, for wires to run between the operator and the yoke end bolster for the infrared detection device, vehicle loop detectors, or any other accessory component at the terminal end of the Drop arm/gate.
- Trench for the operator control panel cables running from locations such as central control rooms, guardhouses, etc. to the operator enclosure.
- Trench for accessory components such as signal lights, traffic lights, external PLC wiring specific to the project.
- Trench for traffic sensor loop installation wiring back to operator.

### Depth, soil compaction, and concrete forming for all systems



**If necessary, review system drawings that came with your order and any applicable project drawings or construction documents.**

If stone is used to level, it must be crushed and compacted to a minimum of 90% dry density. Refer to the foundation drawings for more specific information. It is best to pour the concrete against a clean, tight excavated edge opposed to forming and back filling if the road is not being replaced beyond the excavated site.

### **Concrete**

AutoGate, recommends 4,000 psi concrete with non-shrinking additives. The approximate amount of concrete required based on a 15' clear drivable open system is:

#### **M30 Standard**

Operator Pad: 8.5 cubic yards, see your sign off drawing to compute exact yards.

Bolster Pad: 4.5 cubic yards, see your sign off drawing to compute exact yards.

#### **M30 Shallow Foundation**

Operator Pad: 8.5 cubic yards, see your sign off drawing to compute exact yards.

Bolster Weldment Pad: 18.2 cubic yards, see your sign off drawing to compute exact yards.

#### **M50 Standard**

Operator Pad: 9.5 cubic yards, see your sign off drawing to compute exact yards.

Bolster Pad: 5.5 cubic yards, see your sign off drawing to compute exact yards.

Create a concrete leveling pad for the Bolster per the notes Instruction found on the foundation drawings with your order.



**Make sure you are excavating and placing the Bolster to the correct Hand Orientation. See pages 12-18 for examples and refer to your order drawing.**



## BOLSTER PLANNING & INSTALATION



- Pay close attention to the dimensions on your drawings and any tolerances required! Use laser level devices for accuracy.
- Use a qualified heavy equipment operator or rigger to lift and set the Bolster in place. Improper rigging may cause injury.

### Steel Reinforcement Bars and Rebar—M30 SHALLOW FOUNDATION INSTALLATION ONLY

With the Bolster on top of the road, slide the flat steel reinforcement bars through the I-beams Then lift the entire Bolster into the excavated trench and level.

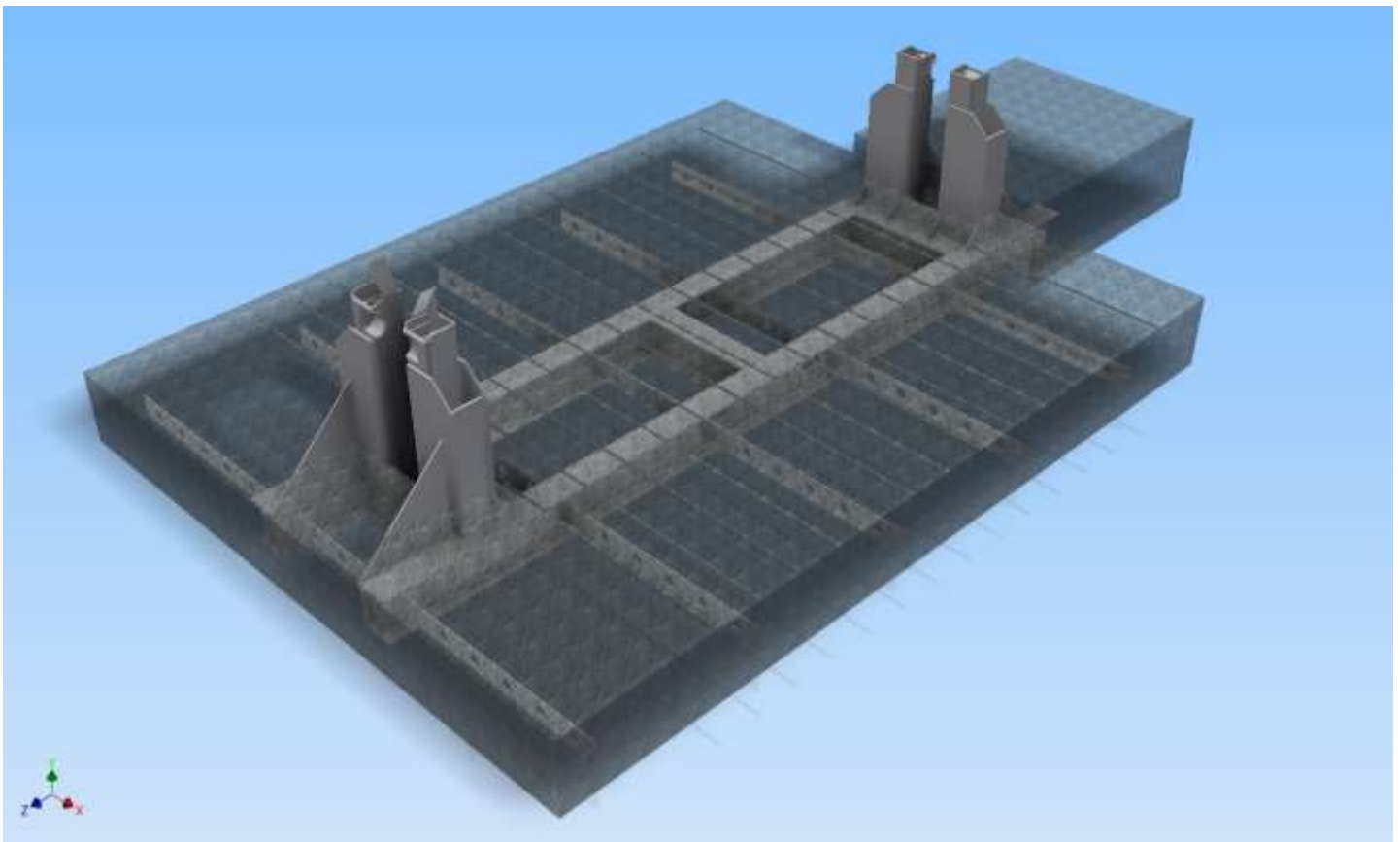

The center section of the Bolster should be filled first. This will minimize the potential for shifting during the pouring process.

## BOLSTER PLANNING & INSTALATION



- Pay close attention to the dimensions on your drawings and any tolerances required! Use laser level devices for accuracy.
- Use a qualified heavy equipment operator or rigger to lift and set the Bolster in place. Improper rigging may cause injury.

### M30 BOLSTERS STANDARD FOUNDATION INSTALLATION ONLY

With the Bolster on top of the road, secure to crane or on-site lift equipment. Then lift the entire Bolster into the excavated foundation and level on leveling pad.



Once leveling of both bolsters is complete and matches your provided installation drawings pour concrete to fill the foundations.

If needed, paint above surface Bolster areas that may have been chipped or exposed during offloading and positioning in excavation with high quality outdoor paint.



**The center section of the Bolster should be filled first. This will minimize the potential for shifting during the pouring process.**

## BOLSTER PLANNING & INSTALATION

### MORE SAMPLE SITE PHOTOS



# BOLSTER PLANNING & INSTALATION

## M50 Foundation Preparation and Installation

### Operator End Bolster

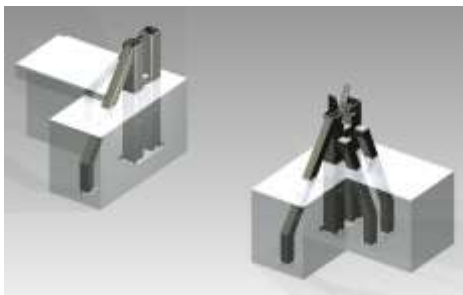

### Yoke End Bolster



## SECTION 4—RECEIVING AND UNLOADING

The Shield operator and gate are typically delivered assembled and on flatbed or step-deck trailers.



**CAUTION:** ALWAYS INSPECT ALL ITEMS FOR DAMAGE BEFORE THE DRIVER LEAVES!  
DOCUMENT ANY DAMAGE ON THE DELIVERY RECEIPT.  
***DO NOT DROP THE GATE OR THE OPERATOR FROM THE TRUCK!***

### Flatbed Carrier Delivery Unloading Tips

- Need to have forklift, crane, Gradall or equal that is load rated to unload your system.
- Be sure to use leveling jacks (if available) to support weight of operator on tail lift
- ***Do not stand under or near the system while lifting***



## PREPERATION, ATTACHING THE DROP ARM, & OPERATOR INSTALATION



### WARNING!

Do not remove the Transport/Maintenance (T/M) Safety Pin until you have read this manual & the Drop arm/gate is securely attached & directed to do so in this manual. The operator arm is under a great deal of spring tension & can cause extreme damage & injury if released prematurely!

## Preparations Prior to Positioning the Operator

### T/M (Transportation & Maintenance) Safety Pin Warning!

When you receive your system it has a safety device called a T/M Safety Pin installed (see below). T/M stands for Transportation and Maintenance because the pin must be installed during shipping, installation, and whenever maintenance is being performed. **Do Not remove this pin until the instructions in this manual direct you to do so!**

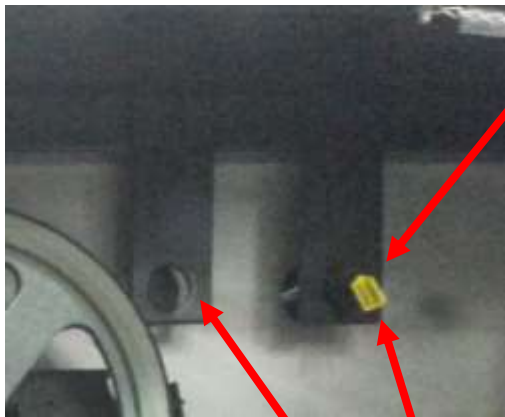

T/M Pin viewed from inside the operator and in the operator throat area.

**\*\*\* CAUTION \*\*\***  
**PIN IS UNDER HIGH TENSION WHEN INSTALLED WITH NO GATE ATTACHED!**



T/M PIN POSITION #2 and #1

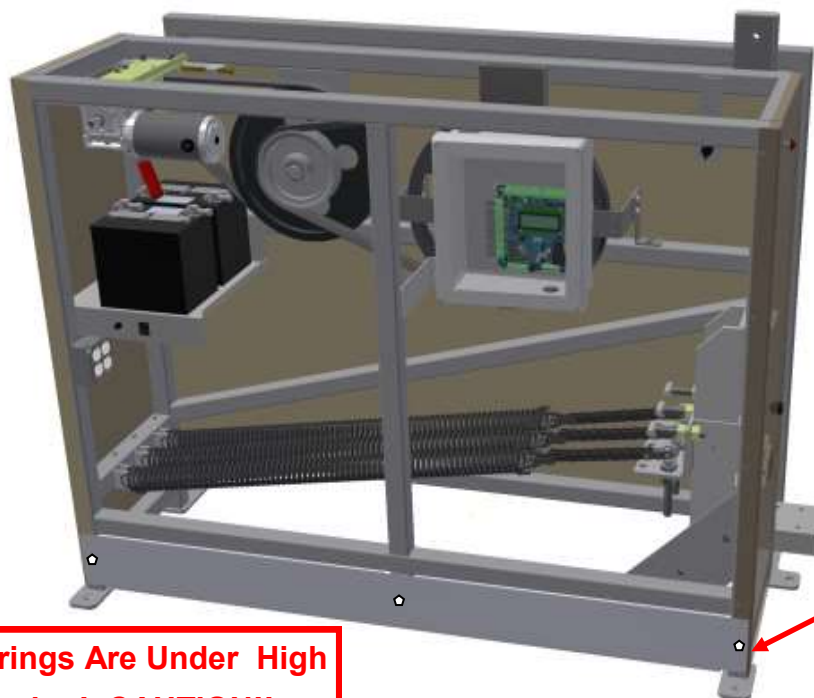

**Springs Are Under High Tension! CAUTION!!**

Install KICK PANEL here with provided TEK screws.



**PREPERATION, ATTACHING THE DROP ARM, & OPERATOR INSTALATION**

Bolt the gate to the Operator Arm Mounting Plate with the bolts supplied. Then attach the Linkage Arm.



**LINKAGE ARM**

**LUG ATTACHEMENT POINT  
(SEE DETAIL BELOW)**

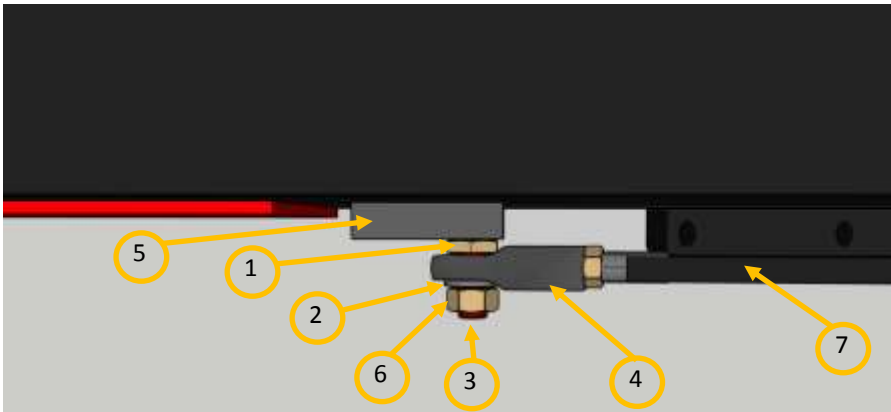

PARTS LIST	
DESCRIPTION	
1	5/8" HEAVY WASHER
2	5/8" S.S. FLAT WASHER
3	5/8-11 x 2-1/4" Stud
4	5/8" DIA. 5/8-18 FEMALE ROD END
5	3/4" x 2" x 4" LUG
6	5/8-18 HEX LOCK NUT
7	LINKAGE ARM

## PREPERATION, ATTACHING THE DROP ARM, & OPERATOR INSTALATION

### Placing the Operator & Drop arm/gate assembly on the Concrete Pad

Be sure the linkage arm attached to the Drop arm/gate is fully straight and in the locked (or over center) position. Press down on the linkage arm to ensure it is in its locked position. **DO NOT REMOVE THE T/M SAFETY PIN UNTIL INSTRUCTED TO!**

Open the operator doors with the supplied keys. The keys to the doors are attached to the T/M Safety Pin keeper (see photo to the left).



**KEYS**



**MANUAL RELEASE LEVER**

**FORKLIFT GUIDES**

### Using a Fork Lift to move and place the operator

1. Remove the T/M Safety Pin (position #1) it may be necessary to push down on the end of Drop arm/gate to take pressure off T/M Safety pin) and insert it in the second set of T/M (position #2) bracket holes. *Note:* the photo below shows the pin in position #2 possible if the Drop arm/gate is completely lowered. The second set of T/M bracket holes (position #2) is primarily used for installation to allow the Drop arm/gate to be raised slightly; however, it can also be used to lock the gate in the fully open position.
2. Once the operator doors are open pull the Manual Release Lever located by the motor.

#### **T/M PIN POSITION #2 and #1**

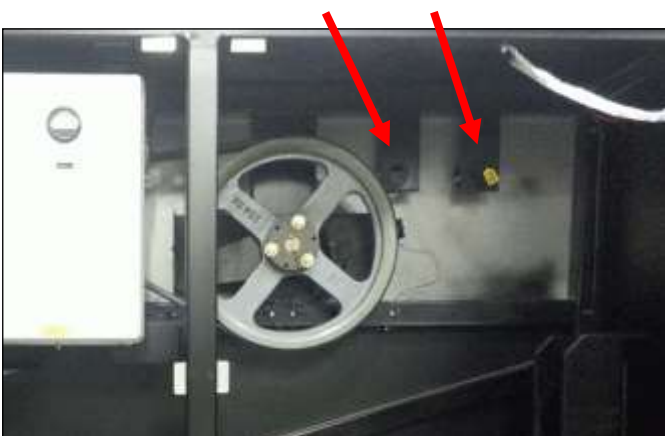

**FORKS GO HERE**



## PREPERATION, ATTACHING THE DROP ARM, & OPERATOR INSTALATION

Close the operator doors and latch them in the closed position so they do not swing open while moving, lifting or adjusting the operator. Using a forklift, with side-shift if possible, insert the forks into the channel receivers on the door side of the operator.



Lift the Linkage Arm at the center point 4-6 inches to release the Drop arm/gate



center point 4-6 inches to release the Drop arm/gate (shown below).

Push the gate open until it rests against the T/M Safety Pin now positioned in the second set of T/M bracket holes (position #2).

From the public side, position the operator in front of the raised concrete pad. Carefully raise the system enough to clear the Bolsters. Slowly advance and lower once the Drop arm/gate is centered between the operator end Bolster as shown below. Once lowered, side shift the system to position the operator end barrier arm pin to be 50% "engaged in the pin cup. Fully lower the system leaving the forklift in place. By design, the YOKE END pin will NOT be 50% in the pin cups.

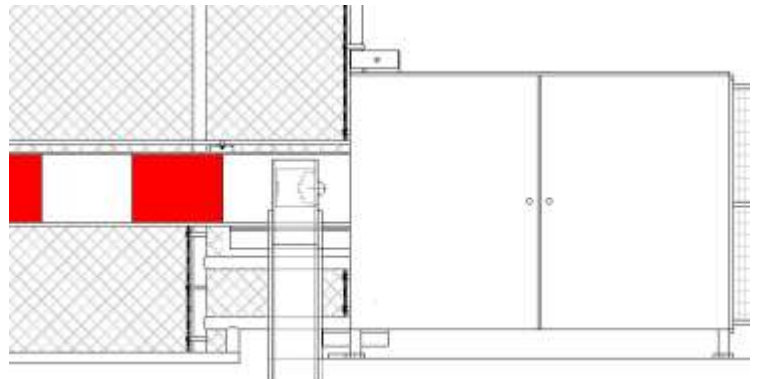

## PREPERATION, ATTACHING THE DROP ARM, & OPERATOR INSTALATION

### Final Positioning of the System (Forklift still in place)

- Pull the gate down to the closed position. Push down on the linkage assembly to lock the Drop arm/gate in the closed position.
- Adjust the operator to center the Drop arm/gate between the Bolsters
- Use caution and remove the T/M pin
- With the forklift still in place pull up on the Linkage Arm and manually move the Drop arm/gate up and down to make sure there are no interferences and the arm can operate freely. Minimum clearance between the barrier yoke end Locking Pin and the yoke end bolster as the Locking Pin passes the top edge of the bolster is 1/2" (see below)
- Lock Drop arm/gate down. Place T/M Pin in position #1. Remove forklift.
- Drill and install concrete anchor bolts (Four 3/4" x 12" wedge bolts provided) to fasten the operator to the raised pad. You do not need to add any type of epoxy to the holes and tighten. They do not need to be torqued. (see below for anchor bolt locations on operator).

#### 1/2" Clearance (minimum)

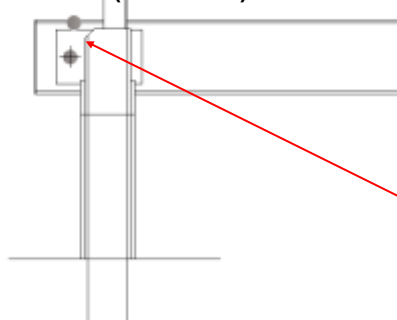

Locking Pin "Pass by Clearance" is a minimum of 1/2" (required). Adjust by repositioning the operator if necessary.

#### Anchor Bolt Locations

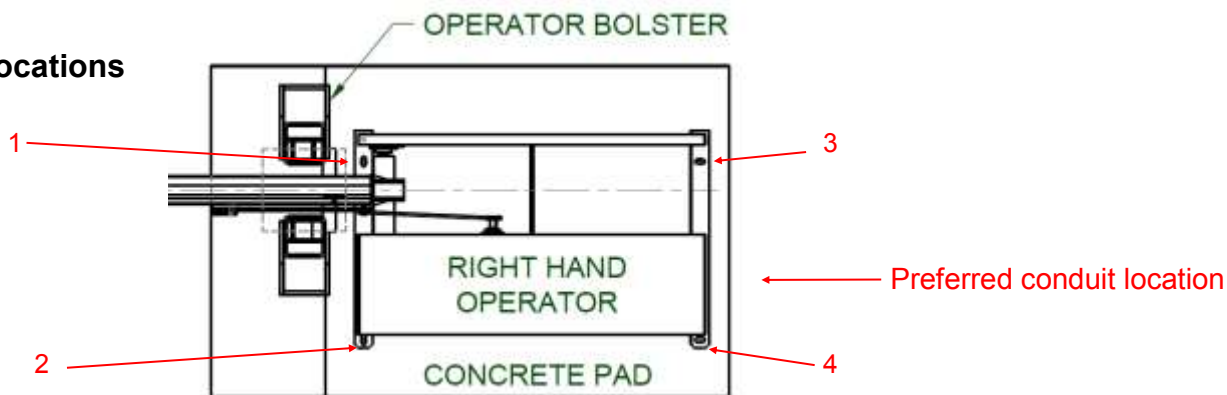

## PREPERATION, ATTACHING THE DROP ARM, & OPERATOR INSTALATION

### Supplementary Tasks Following Final Positioning & Before Initial Operation

Before beginning routine operation of your barrier system, you must complete several other tasks to ensure the gate is ready for service and is operating correctly.

Remove the T/M Safety Pin and properly stow on the stowage hook inside the operator.

T/M SAFETY PIN STORED



Attach the kick panel to the door side of the operator using #12 x 3/4" TEK (self-drilling screws provided). The kick panel blocks any reaching under and into the operator to prevent injury during operation. It also blocks debris and vamints from getting underneath.

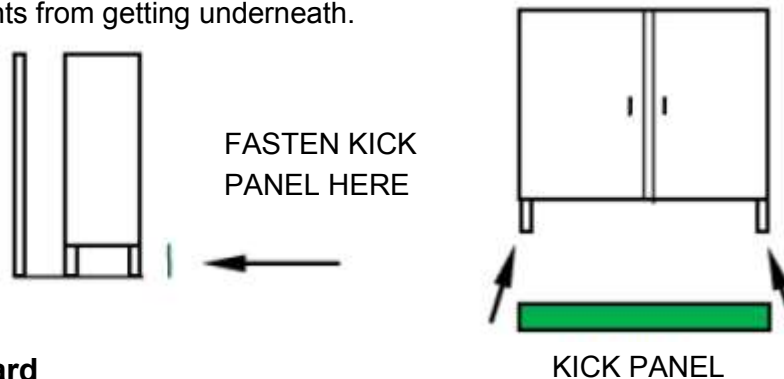

### Attach The Gate Guard

If shipped unattached, mount the gate guard to the back of the operator cabinet to cover the opening at the end opposite the Drop arm/gate using #12 x 2.0" TEK (self-drilling screws provided).

Gate Guard



## GATE GUARDS, SIGNS, AND REFLECTIVE TAPE

- |   |   |
|---|---|
| 1 | AutoGate provides Gate Guards up to 9' tall gates.  |
| 2 | Gates over 9' tall will require local fencing to restrict pedestrian access avoiding injury or entrapment (see attached shaded area)                                  |
| 3 | Fence off all pinch point or entrapment areas per F2200 and/or use external entrapment protection devices such as Photo Eyes or Contact Sensors.                      |
| 4 | Be mindful of the rear area of the gate operator that may have a moving gate panel extending outward from it. Mitigate potential injury to pedestrians and equipment. |

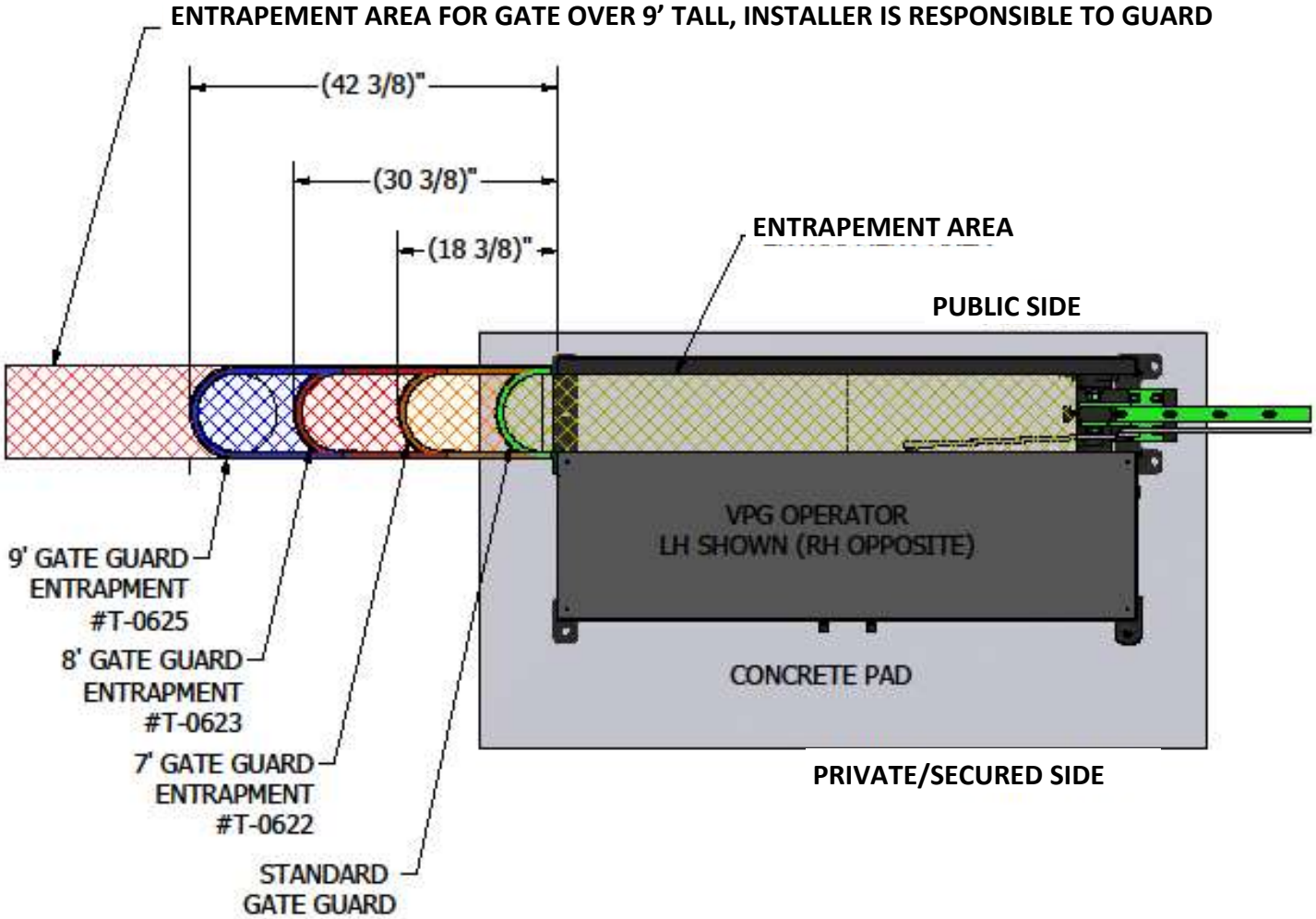
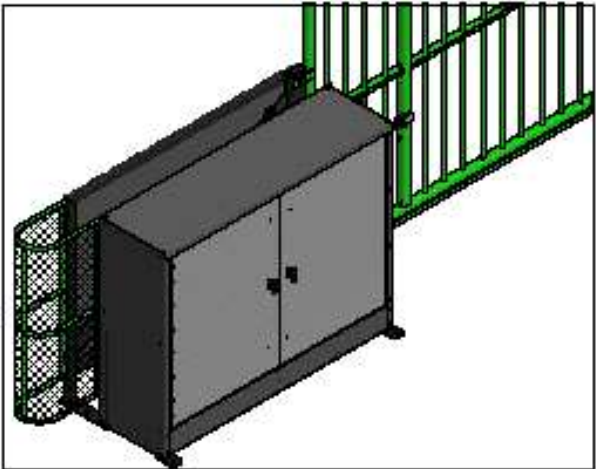

## GATE GUARDS, SIGNS, AND REFLECTIVE TAPE

- DO NOT affix any adhesive material within 30 days of receiving the system.
- The gate and operator are designed to work together. DO NOT attempt to install or affix an unauthorized gate without AutoGate's prior authorization and instructions, doing so may VOID the operator warranty.
- DO NOT ALLOW any access control devices to be mounted within 6 feet of the moving gate or in such a way that someone could reach their hand or arm through the gate to activate it.

### Warning Signs

AutoGate recommends any additional signage be installed between the operator and the center of the Drop arm/gate. **DO NOT DRILL OR PIERCE THE DROP ARM/GATE.** This will allow undesired water, ice, and condensation to enter the Drop arm/gate and void your warranty. Alternate fastening method is required (ex: ultra high bond exterior tape) to avoid violating the warranty.

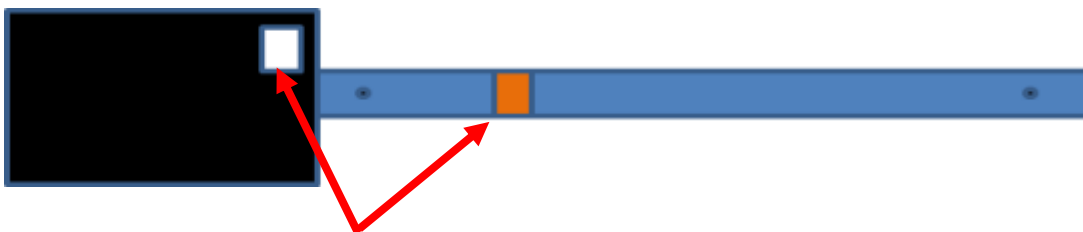

**EXAMPLE SIGN LOCATIONS**



### Reflective Tape & Warning Lights

Several organization's and standards now specify that Active Barrier Systems and non-crash barrier systems are to be conspicuously marked and or have warning lights for the system. Some of the organizations and standards are, but not limited to: Surface Deployment and Distribution Command Transportation Engineering Agency (SDDCTEA), Manual of Uniform Traffic Control Devices (MUTCD), Unified Facilities Criteria (UFC), Department of Transportation (DOT), Federal Highway Administration (FHA), etc. Below you will see an example of a Drop arm/gate system with a gate panel fabricated to the Arm (optional), High Intensity Prismatic Reflective Tape, and LED lights mounted to and fully protected by rigid conduit.

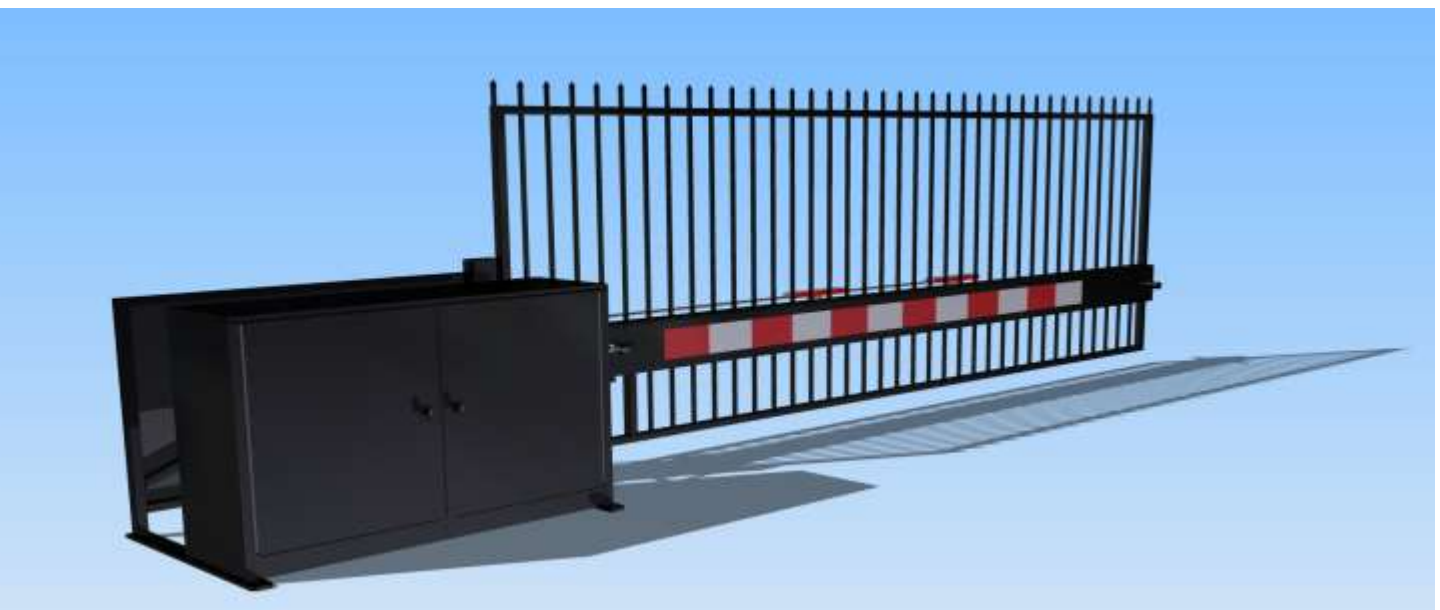

## EARTH GROUND AND LIGHTNING PROTECTION

Install an approved 8' earth ground rod 6" to 3' off the rear side of operator pad\*. The Ground wire connection is located inside the door. Recommended wire is #8 gauge or larger. **NEVER splice the ground wire!**

Improper grounding will make the operator more susceptible to lightning or surge damage and can affect GENESIS Board or accessories.

To Operator

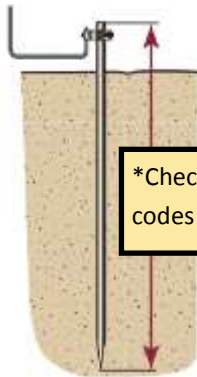

\*Check national and local codes for proper depth.

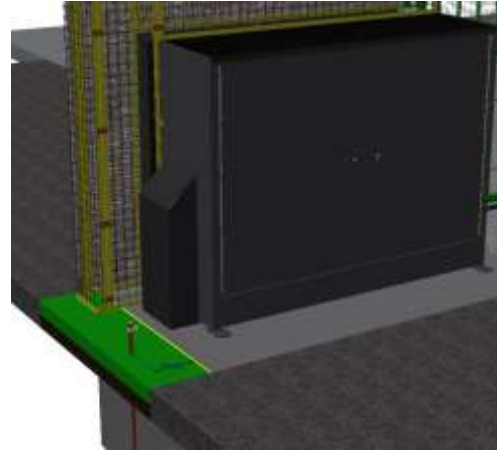

## BATTERY WIRING AND INSTALLATION

The Genesis controller has a built-in battery charging system that has multiple formats. The charging sequence can handle full size flooded batteries as well as sealed lead acid or AGM batteries. The Genesis primary input voltage can also be connected directly to solar panel(s) for non-AC operation. The built-in charger when programmed for solar will allow the system to run off the batteries and will still charge them during the daylight hours.

Install Two (2) 12 VDC Batteries (**Required, not provided**) on the battery shelf. AutoGate recommends Group 24 Deep Cycle Marine Starting batteries for extended battery back up. At a minimum use (2) 7AH batteries for battery back up.

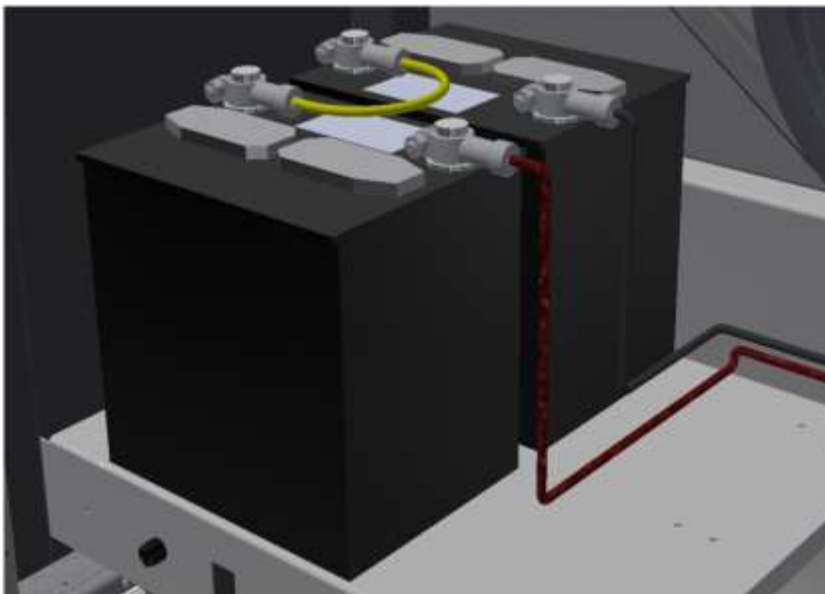

### Typical 24V series connection

- 1) Jumper wire from battery 1 NEGATIVE is connected to battery 2 POSITIVE.
- 2) Wire from battery 1 POSITIVE to POSITIVE terminal on control board
- 3) Wire from battery 2 NEGATIVE to NEGATIVE terminal on control board.

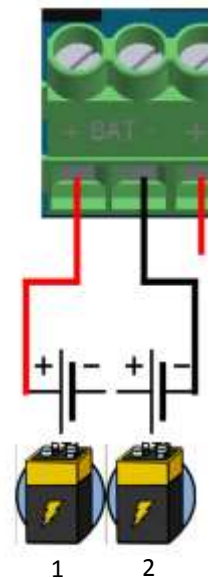

Batteries will charge when AC power or Solar Panels are present and power gate automatically without any changes in wiring. **Note:** Solar applications will require a program selection in the board menu (see page ??).

## SECTION 5—OPERATOR ELECTRICAL

The AutoGate Genesis control board is DC powered as is the motor with built in full battery back-up. Primary power is supplied by an AC/DC rectified output power supply (see below). Input AC is supplied through a dedicated 20 Amp breaker. Voltage is selectable, 90~132 VAC / 180~264 VAC via slide switch. This protects the Genesis controller from random or storm induced power surges on while AC power. The Earth Ground connection on the board is to aid in surge protection and random voltage issues.

**NOTE: There is NO AC power inside the Control Board Enclosure!**

### A/C POWER CONNECTION



**WARNING: ALL 120VAC OR 240VAC ELECTRICAL CONNECTIONS FROM SERVICE PANEL TO THE GATE OPERATOR MUST BE MADE BY A LICENSED ELECTRICIAN!**

- Run AC power lines through conduit to junction box (see below) located inside the operator. (see typical conduit locations drawings page 14. Contact AutoGate for Optional routing).
- All AC power and control wiring **MUST** be run in separate conduits
- Before doing any wiring inside the operator ensure that the main power source has been disabled at the main circuit breaker. If this is a **SOLAR** application, ensure the power input is disconnected.
- The Power Supply will be wired at the factory, you only need to hook the AC into the supplied junction box.

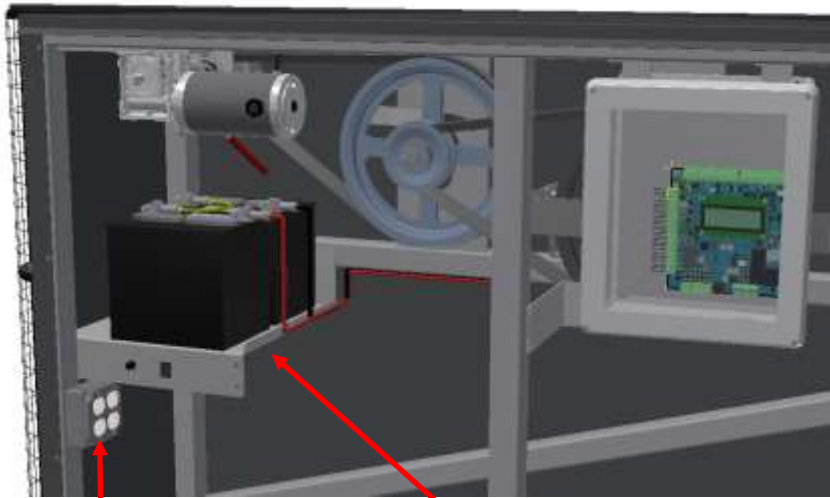

AC Junction Box

Rectified Power Supply  
(Mounted under the  
battery shelf)



P11

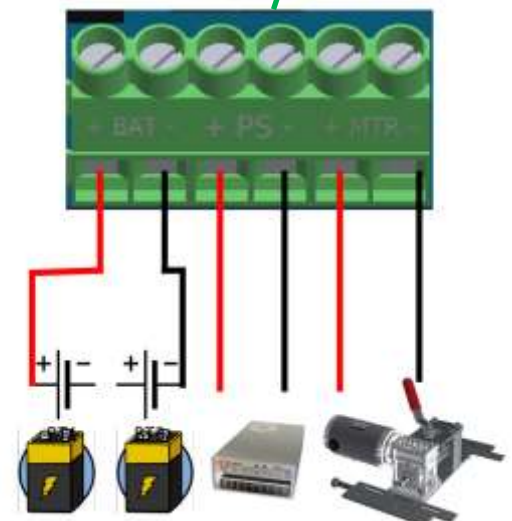

**SECTION 6—GENESIS CONTROL BOARD**

**POWER** Indicator. If the **GREEN** light is flashing, there is power to the board.

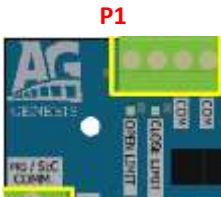
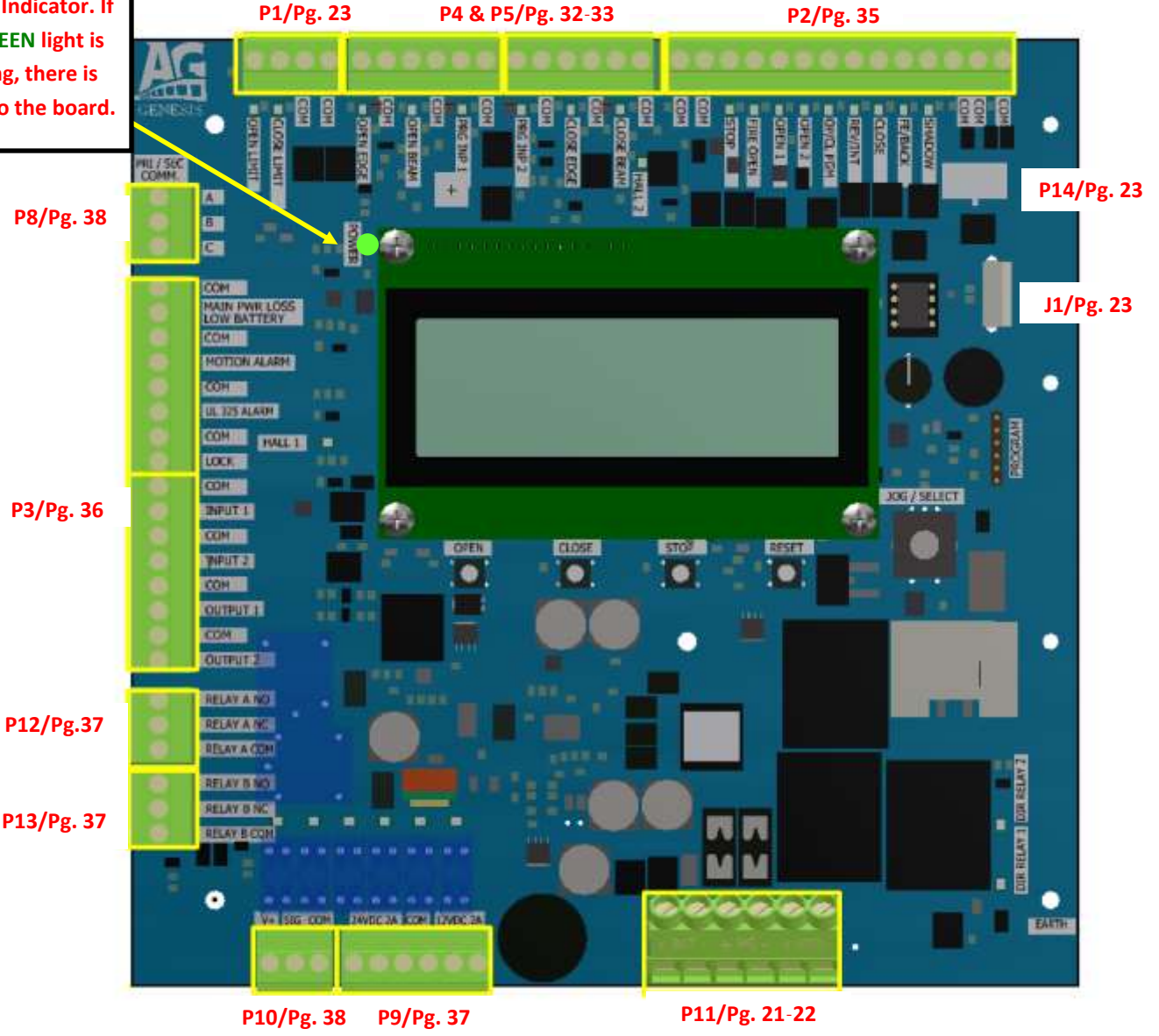

**Note:** **P1** is NOT USED on the VPG2490 model or any CRASH SHIELD systems. They use a **Limit Position Sensor (LPS)**. **P1** would only be used in you were to install the GENESIS board in an older operator with limit switches.

**P14**– Loop Rack Accessory Wiring harness port: Used with our LR-3 Loop Rack board

**J1**-USB For data connection

**P6**-Program Plug: Used to update board software



# OPERATOR WIRING DIAGRAM

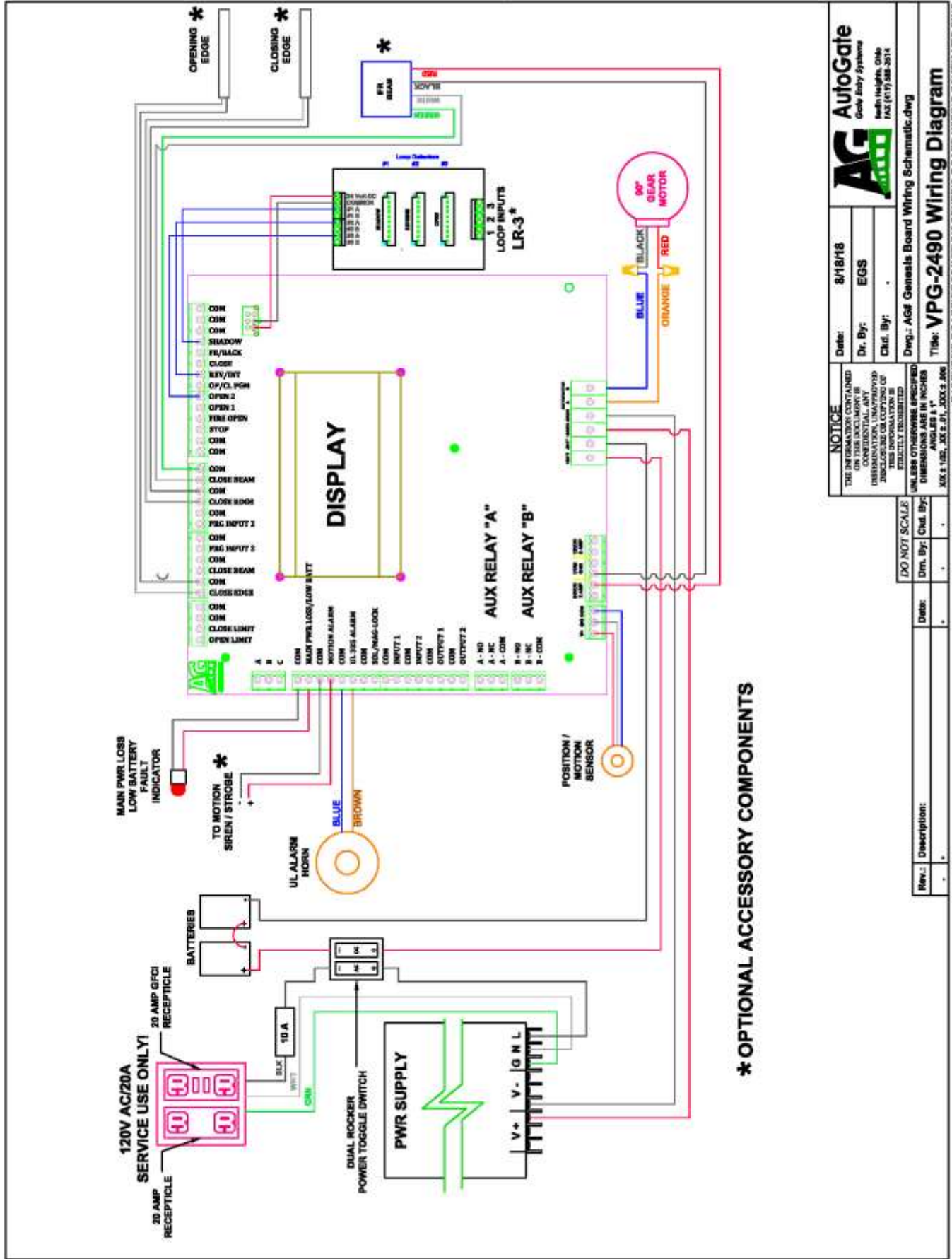

**\* OPTIONAL ACCESSORY COMPONENTS**

<b>AutoGate</b> Gate Entry Systems	
Date: 8/18/18	Dr. By: EGS
Ck. By: .	
Dwg.: AGI Genesis Board Wiring Schematic.dwg	
Title: VPG-2490 Wiring Diagram	

<p><b>NOTICE</b></p> <p>THE INFORMATION CONTAINED ON THIS DOCUMENT IS CONFIDENTIAL AND PROPRIETARY. ANY DISCLOSURE OR REPRODUCTION OF THIS INFORMATION IS STRICTLY PROHIBITED.</p> <p>UNLESS OTHERWISE SPECIFIED DIMENSIONS ARE IN INCHES.</p> <p>ANGLES &amp; 1"</p> <p>AUX. 1 1/2", 30 &amp; 31, AUX. 2 3/8"</p>	
DO NOT SCALE	Date: .
Drn. By: .	Ck. By: .
Rev.:	Description:

## SAFETY & HELPFUL INFORMATION



DO NOT ALLOW any access control devices to be mounted within 6 feet of the moving gate or in such a way that someone could reach their hand or arm through the gate to activate it.

## SHIELD ENTRAPMENT PROTECTION

The Genesis controller is equipped with Type “A” inherent obstruction sensing and has 6 monitored entrapment inputs. The monitored inputs will be initially programmed at factory but are field selectable. There are edge and beam inputs for both “Open” and “Close” directions. **Please note that a minimum of one “open” and one “close” approved monitored entrapment device must be present along with one Type “A” device for the gate operator to function.** There are 2 programmable monitored inputs for open or close, and either can be edge or beam. All inputs are capable of 10K or 2-wire pulse, and will be programmable in the field. Any additional entrapment areas must be protected in a similar way with approved monitored devices. **However, if you are using NON-MONITORED “Reversing” equipment, you will need to contact AutoGate for a PASSCODE to put your GENESIS board in a NON-MONITORED state for operation.**

For sites requiring more ridged security requirements and alternative connections and configurations with a Program Logic Board (PLC) or similar contact AutoGate for assistance.

All areas of the moving vertical pivot gate panel from the bottom of the gate to the top of the gate or a minimum of 1.83 m (72 in) above grade, whichever is less, that pass by a fixed stationary object, and in the area of the adjacent fence that the gate covers during the travel of the gate, shall be designed, guarded or screened to prevent a 57 mm (2-1/4 in) diameter sphere from passing through such areas.

The Shield is equipped with one (1) INTERNAL means of entrapment sensing device. AutoGate highly recommends the use of additional EXTERNAL entrapment sensing devices. Both INTERNAL and EXTERNAL are listed below.

## APPROVED PROTECTION DEVICES FOR THIS OPERATOR

### Type B1 (non-contact) devices

#### Open or Opening

Your Vertical Pivot operator requires a minimum of ONE OPEN external obstruct and ONE CLOSED ion device to be wired to the Genesis Control board to operate. You may use any approved device listed below. The face and the throat area are required to be protected per UL325 7th edition.

The Genesis board supports use of a maximum of four type B1 devices.

- Open Beam
- Close Beam
- (2) Programmable Inputs



#### Close or Closing

Photoelectric sensors/beams should be positioned on the bolsters in the pre-drilled hole locations. Review your site drawings for locations.

**Approved Non-Contact Devices:** EMX IRB-Mon, EMX IRB-RET & OMRON EK3

## SECTION —ENTRAPMENT PROTECTION DEVICE INSTALLATION AND WIRING

### MONITORED DEVICE CONNECTIONS POINTS

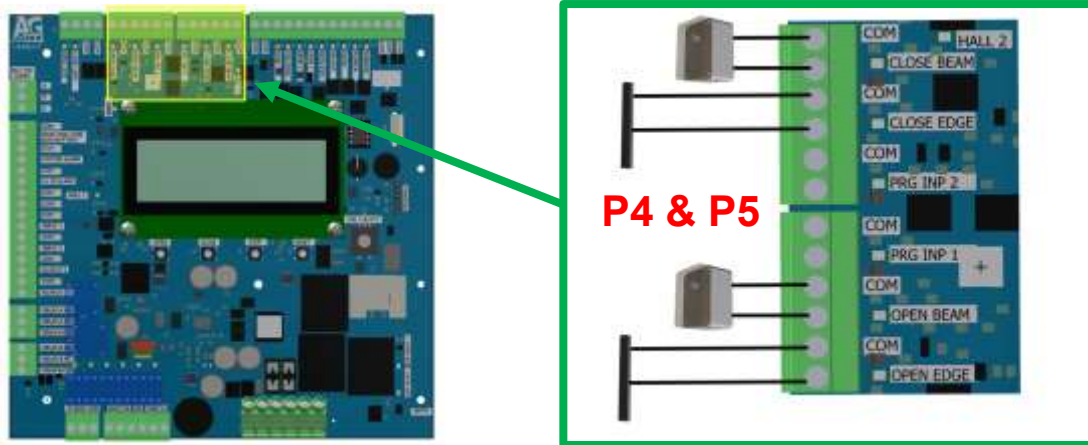

### NON-MONITORED DEVICE CONNECTIONS POINTS

Connection points for NON-MONITORED Photo Beams and Contact Edges will be wired to the terminals on the P2 terminal strip. In order to operate your gate system, you will need to contact AutoGate for a PASSCODE to put your GENESIS board in a NON-MONITORED state for operation.

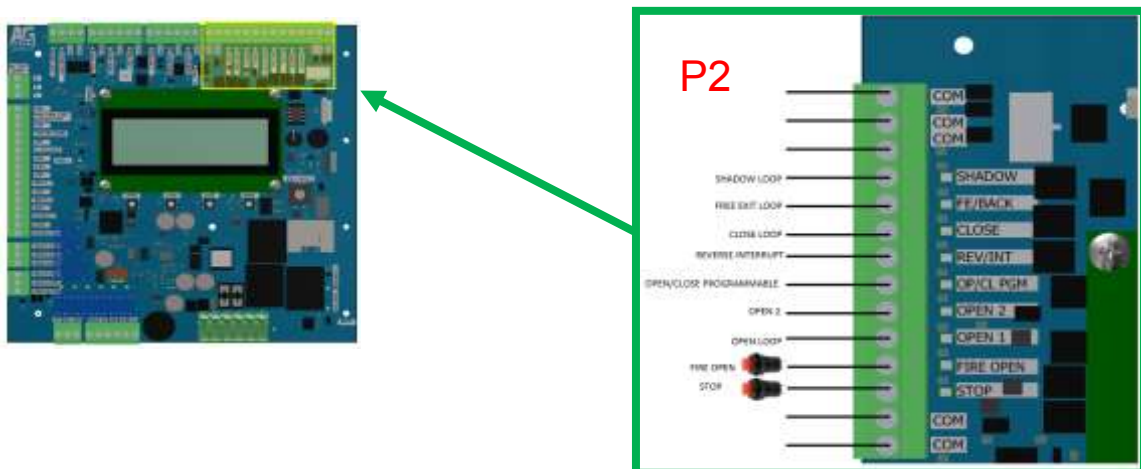

## ENTRAPMENT PROTECTION DEVICE INSTALLATION AND WIRING

### Type B2 (contact)

#### Contact Edge Sensors

##### Close or Closing

Contact edges on the bottom of the gate are often added as an extra entrapment device for the closing mode. We do not recommend a contact edge to be the only external entrapment device for the closing mode.

- Open Edge
- Close Edge
- Programmable Inputs (x2)



**Approved Edge Sensor Devices:** Miller Edge CPT 223, ASO SENTIR 15-10VT, 45 STKS4

##### Open or Opening

Your Vertical Pivot operator now requires a minimum of (1) OPEN obstruction device to be wired to the Genesis Control board to operate. You may use any approved device listed above. The face and the throat area are required to be protected per UL325 7th edition.

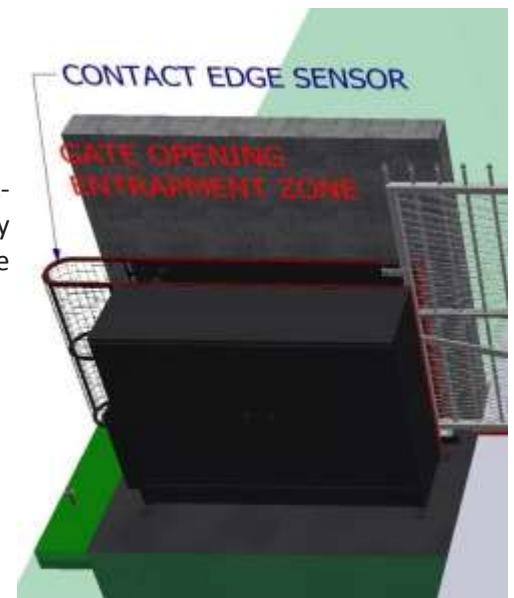

#### MONITORED DEVICE CONNECTIONS POINTS

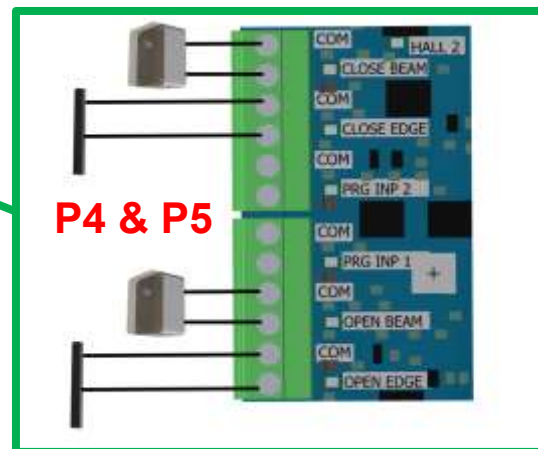
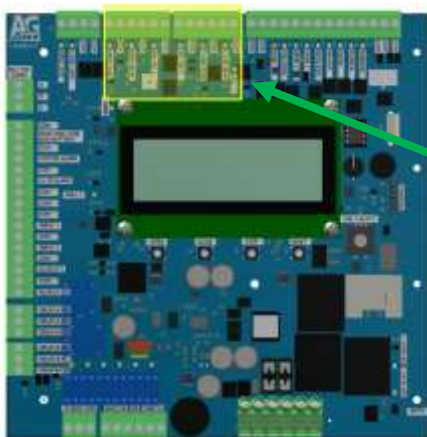

NOTE: The two programmable inputs can be configured as either edge or beam and as either open or close.

## GENESIS BOARD P2 TERMINAL CONNECTIONS

In addition to the entrapment sensor inputs there are operational inputs for vehicle detection, communication with another gate or similar device as well as push buttons for control of various modes of operation.

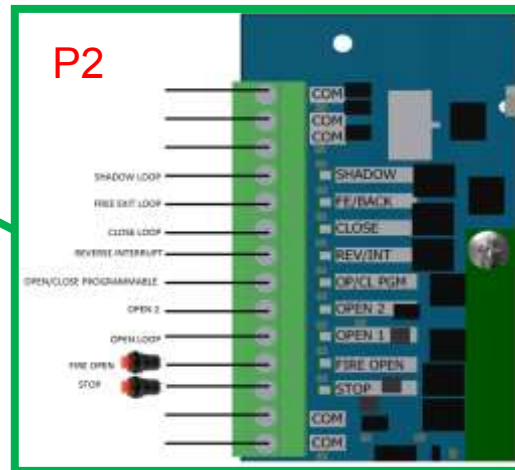
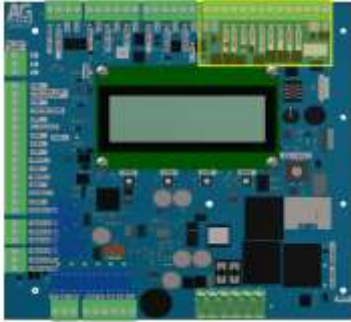

INPUT NAME	FUNCTION AFTER MOMENTARY TRIGGER	FUNCTION DURING CONTINUOUS TRIGGER
<b>Shadow Loop</b>	While at open limit, hold open, ignore once off of the open limit switch. <i>(Not common on Vertical Pivot Gate)</i>	Hold Open
<b>FE/Back (Free Exit/ Back Away)</b>	Opens Drop arm/gate as Open1, but when signal is removed, Drop arm/gate is given command to close. (Close command over ridden by any other open or Reverse/Interrupt command or stop command) (Primarily designed to work with FE/Back on standard traffic-Barrier Arms)	Starts opening movement from any position
<b>Close Loop</b>	Start closing movement from any position, Open commands can override. If Drop arm/gate is closing when activated, Drop arm/gate stops until clear and then continues to close. Close input responds on release of the input normally. Close input will hold the Drop arm/gate open while input is maintained with the Drop arm/gate in the open position. When in constant pressure mode, close input responds on initial press. <i>(Not common on Vertical Pivot Gate)</i>	If held in upward motion, no effect. If held in downward motion, gate movement is paused until released and continues downward on release
<b>Reverse/Interrupt</b>	When closing, stops and re-opens.	If held, stay open
<b>Open / Close PGM</b>	When menu option not enabled, Input = open 1 only. When enabled, input = Open 1 unless the open limit is reached, it then turns to Close. If input is held during OPEN, Drop arm/gate holds open. Input needs to cycle off before input can CLOSE Drop arm/gate.	If held it remains in its state
<b>Open 1</b>	starts opening movement from any position	starts opening from any position
<b>Open 2</b>	starts opening movement from any position	Same as above
<b>Fire Open</b>	Absolute open, until the board is hard power reset, or local reset button pushed	Locks Drop arm/gate open until released
<b>Stop</b>	Stops gate at any point and cancels current inputs. Inputs will be ignored until stop is released. A stop input will disable the auto-close timer	If held, no Drop arm/gate movement, inputs ignored.

## GENESIS BOARD P3 TERMINAL CONNECTIONS

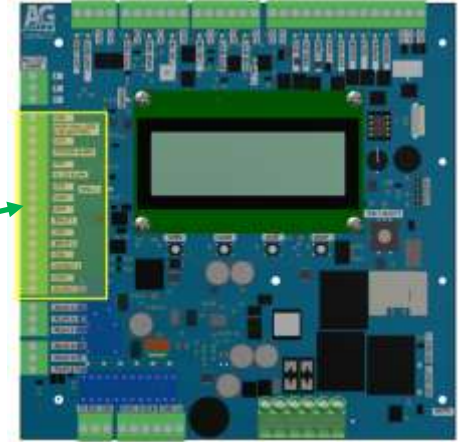
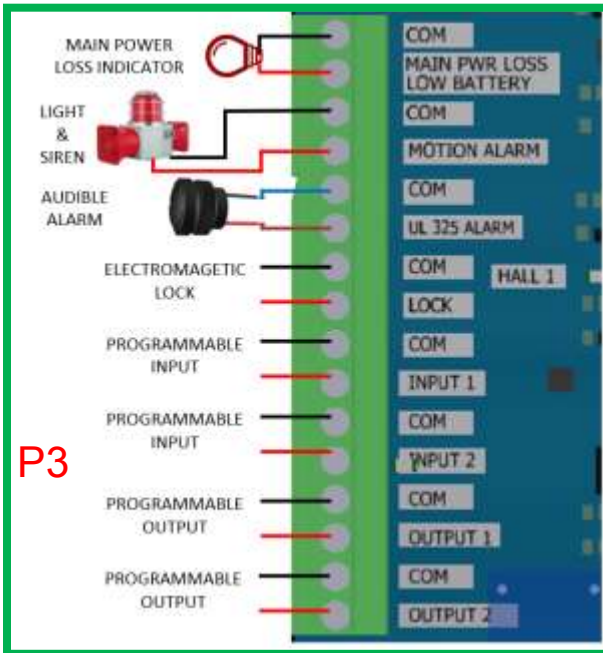

<b>Warning Light</b>	<p><b>Four States</b></p> <p><b>OFF:</b> No faults</p> <p><b>FAST Blink:</b> Low battery voltage</p> <p><b>DOUBLE PULSE Blink:</b> Loss of AC power</p> <p><b>SLOW Blink:</b> Any other fault</p> <p><i>priority for the signals are:</i></p> <ol style="list-style-type: none"> <li>1 - Low battery</li> <li>2 - Loss of AC</li> <li>3 - Any other fault</li> </ol>
<b>Motion Alarm</b>	Active for full cycle ( <b>ON-OFF</b> menu selectable). Programmable for pre-movement opening (0-5 seconds menu selectable). Programmable for pre-movement closing (0-5 seconds menu selectable).
<b>UL325 Alarm</b>	Active for conditions related to UL325 specifications
<b>Lock</b>	<p><b>Programmable/Selectable:</b></p> <p><b>Magnetic lock option</b> - Active when the Drop arm/gate is closed.</p> <p><b>Solenoid Interlock option</b> - Momentary activation to open the bolt that mechanically latches the gate closed.</p>
<b>Input 1</b>	<b>OPTIONS:</b> OFF, OPEN, CLOSE, Single Button, Reverse, Fire, Shadow, Auto Open, Hold Open, Emergency Secure, Auxiliary Pulse 1 & 2, Auxiliary Hold 1 & 2
<b>Input 2</b>	Same as INPUT 1
<b>Output 1</b>	<b>OPTIONS:</b> OFF, Pulse on Open or Close Limit, Hold on Open or & Close Limit, Pulse on motor Open or Close, Hold on Motor Open or Close, Hold on UL Alarm, Hold on Motor Run
<b>Output 2</b>	Same as Output 1

## OPERATIONAL OUTPUTS

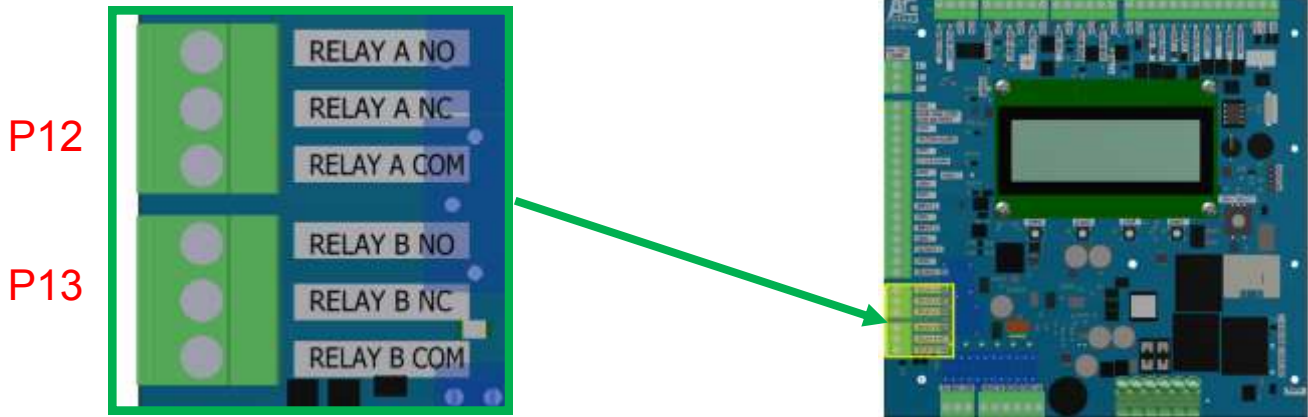

**AUX Relays A & B:** Are programmable for operation based on gate action or position. Both relays

<b>AUXILIARY RELAYS A &amp; B</b>	<p><b>OPTIONS:</b></p> <ul style="list-style-type: none"> <li>OFF</li> <li>Pulse on OPEN Limit: 2-second Relay Activation</li> <li>Pulse on CLOSE Limit: 2-second Relay Activation</li> <li>Hold on OPEN Limit: Latches Relay ON during OPEN Limit</li> <li>Hold on CLOSE Limit: Latches Relay ON during CLOSE Limit</li> <li>Pulse on Motor OPEN: 2-second Pulse when Drop arm/gate starts to move OPEN</li> <li>Pulse on Motor CLOSE: 2-second Pulse when Drop arm/gate starts to CLOSE</li> <li>Hold on Motor OPEN: Latches Relay on when Drop arm/gate is OPENING</li> <li>Hold on Motor CLOSE: Latches Relay ON when Drop arm/gate is CLOSING</li> </ul>
-----------------------------------	---

## POWER FOR EXTERNAL DEVICES

The Genesis board has (2) 24VDC outputs and (2) 12VDC outputs to power external devices. Each is fused at 2 AMPS.

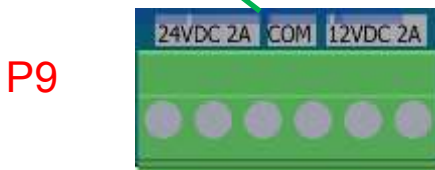
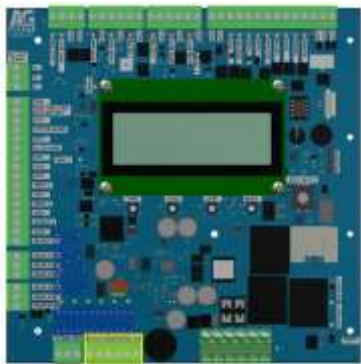

24VDC	ACCESSORY Power	(2) Fused at a total of 2 Amps
12VDC	ACCESSORY Power	(2) Fused at a total of 2 Amps

## COMMUNICATIONS AND POSITION SENSOR

Primary/Secondary communications allow for communications between gates for Dual Gate configurations. *(Not used on SHIELD CRASH systems. Information purposes only)*



### PRIMARY/SECONDARY OR DUAL GATES

When using two gates to cover a driveway and they both need to cycle together on an open input. Connect the two boards with a 4-conductor SHIELDED 18 ga. wire (3 required, 1-spare) and set the following board parameters:

```
>Dual Gate Mode:
  Off
```

**P/M:** Set for Primary /Secondary communication. Gates need to communicate with each other to work properly.

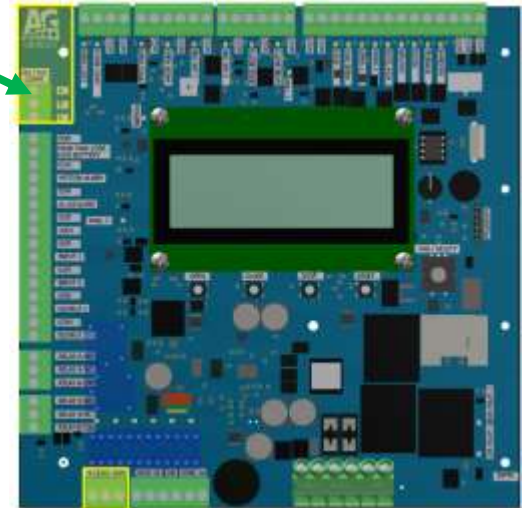

### LIMIT/POSITION SENSOR (LPS)

Your gate is equipped with a LIMIT/POSITION SENSOR. It will be properly set when it leaves the factory. If you need to adjust it, refer to the instructions below. If you need to replace, contact AutoGate.

```
>Op: 4500 Ramp: 4000
  Gate 1
```

#### ADJUSTING THE LIMIT/POSITION SENSOR

**WARNING! This screen requires a PASSCODE to access.**

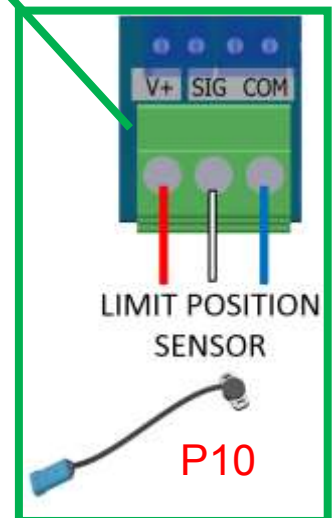

1. In programming mode, Set your cursor to the GATE (line 2) and enter (>Gate). Using the Jog knob you can slightly adjust the OPEN or CLOSE position by turning it left or right.
2. Once you have readjusted your gate position, "enter" again to back out of the Gate line and go up to the **Op:** line or down to the **Cl:** line to set your new numbers.



## ENTRAPMENT PROTECTION DEVICE FUNCTIONAL CHARACTERISTICS

<b>Monitored Open Edge</b>	When activated, the Drop arm/gate will stop, (in less than 2 seconds), and then reverse and go to a full close secured position. Drop arm/gate will remain closed until it receives an “INTENDED” INPUT (Keypad/Reader/Push Button/Free Exit) or the board is manually reset (Not from an Entrapment input).
<b>Monitored Open Beam</b>	When activated, the Drop arm/gate will stop, (in less than 2 seconds), and then reverse and go to a full close secured position. Drop arm/gate will remain closed until it receives an “INTENDED” INPUT (Keypad/Reader/Push Button/Free Exit) or the board is manually reset (Not from an Entrapment input).
<b>Monitored Programmable Input 1 &amp; 2</b>	Choice of Open or Close direction by Menu, choice of Edge or Beam and then 10K or 2 wire by Menu.  <i>(Refer to PROGRAMMABLE INPUT FUNCTIONAL descriptions for required action.)</i>
<b>Monitored Close Edge</b>	<p>When activated the first time, the Drop arm/gate will stop in less than 2 seconds, and reverse to full open and allow the ‘Timer To Close’ to be activated upon open limit. Upon the second activation closing, before reaching the close limit, the Drop arm/gate will again stop, (in less than 2 seconds), and reverse to full open and the ‘Timer To Close’ will be deactivated. The Drop arm/gate will remain at full open until an “INTENDED” INPUT is activated (Keypad/Reader/Push Button/Free Exit) . The close command will close the Drop arm/gate and clear the hold command. An ‘Open’ command or a “Reverse” command, (not the Close Beam input) will trigger the reset of the ‘Timer To Close’ activation. Also, any of the action buttons on the control board can activate the Drop arm/gate, (Close button will close Drop arm/gate and the Open &amp; Stop buttons will reset the ‘Timer To Close’ to be active).</p> <p>Note: Upon the second activation before reaching the close limit, when the Drop arm/gate is in the “HOLD” condition, any input that was being maintained at the time of the second activation shall be ignored until the Drop arm/gate is enabled by a different input! If the CLOSE EDGE remains activated, no input will release the Drop arm/gate for operation.</p>
<b>Monitored Close Beam</b>	When activated, the Drop arm/gate shall stop in less than 2 seconds, and then reverse to full open. The ‘Timer to close’ will become active only after all inputs are clear.

## GENESIS PROGRAMING

**OVERVIEW:** The Genesis board has a 4 line 20 characters per line LCD backlit screen. At power up, the display will show the AutoGate and Genesis branding, along with the program version number and the current time. After 5 or 6 seconds, this will then shift to the HOME screen, or base operational data shown below under MAIN SCREEN.

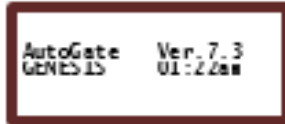

TITLE SCREEN

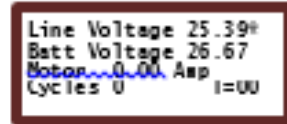

MAIN SCREEN

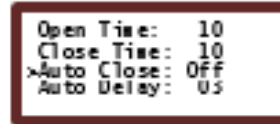

Example 1

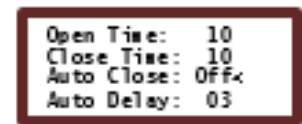

Example 2

**JOG/SELECT Control Knob:** The screens are accessed and modified by a JOG/SELECT control knob. Turning the Jog/Select dial will scroll through the sub-menu selections. When a Sub Menu is showing, a quick momentary press of the Jog/Select knob will display the first screen in that sub menu. Turning the Jog/Select knob will move the cursor (>) through the adjustable parameters.



JOG/SELECT Knob

**SCROLLING:** Rotating the Jog/Select knob clockwise will scroll through the adjustments on that screen. If there is another screen in that sub-section, continue to scroll after the last character, the screen will automatically change to the next screen. When at the last screen of a sub-section, a long push, (approx. 1 second), of the Jog/Select knob will return to the Sub-Section main screen. Sub Sections can be scrolled in either direction by turning the Jog/Select knob clockwise or counter-clockwise.

**JOG/SELECT ACTIONS:** Two different actions can occur on the screens:

- 1) If the cursor is pointed to a descriptive phrase (Example #1), then a momentary push of the Jog/Select knob will move the cursor to the adjustable parameter. Then turning the Jog/Select knob will change the value.
- 2) When the cursor is pointed to left side of a value or parameter to be changed, (example #2), use quick momentary push of the Jog/Select knob to move the cursor. The cursor will move to the right side of the value (<). Turning the Jog/Select knob will change the value. When done, again, a quick momentary push of the Jog/Select knob moves the cursor back to the left.

**Note:** Gate will not be operation while in programming mode. When in programming mode there will be a series of flashing lights at all times above the LCD screen.

**Note:** Screens in ORANGE are WARNING screens that will appear when there is an issue.

### SCREEN MENUS

#### MAIN SCREEN

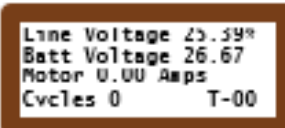

**Line voltage:** From the Power supply. (Normal voltage will be 26 to 27, Preset to 26.5Vdc)

**Battery voltage:** When AC present: Charging Voltage to batteries, When on DC only: Actual battery voltage. (Normal voltage is 26.4 to 26.8)

**Motor:** Displays actual motor amperage during cycling

**Cycles:** A cycle count is considered a complete OPEN & CLOSE

**T=00:** Operation count in seconds for both open and close cycles and also counts down the "Timer to Close" [CLOSE TIME] time.

#### CALENDAR/TIME



Set the time, date and day of the week.

# GENESIS PROGRAMING

## CALENDAR/TIME (Con't.)

```
>01:14:58 am
03/21/19 Th
```

Set the time, date and day of the week.

## TIMER SETTINGS

```
Timer Settings
```

TIMER SETTINGS: 4 Sub Menus to set OPEN & CLOSE times, Motion ALARM times and 7-DAY TIMERS

```
>Open time: 10
Close Time: 10
Auto Close: off
Auto Delay: 03
```

OPEN/CLOSE TIME: Full Speed Run Time, Set this when the slow down is to start. Slows down after time value expires. **This option is only active when LIMIT SWITCHES are used.**

AUTO CLOSE TIME: Default is ON from 1 to 90 seconds, OFF requires a CLOSE command.

CLOSE TIME DELAY: Timer to close after all inputs are clear. Settable from 1 to 90 seconds.

```
>Motion Alarm: Un
Pre-Op Alarm: 0
Pre-Ct Alarm: 0
```

MOTION ALARM: Turns ON and OFF an alarm or Strobe Light.

PRE-OPEN ALARM: Turns on the alarm from 1 to 5 seconds before the gate opens.

PRE-CLOSE ALARM: Turns on the alarm from 1 to 5 seconds before the gate closes.

\*Note: This time value must be equal to or shorter than the AUTO CLOSE TIME value.

```
>Automatic Schedule:
Off
```

AUTOMATIC SCHEDULE: Sets the gate to lock OPEN and CLOSE daily, 7 Days a week, Monday thru Friday or Saturday & Sunday only

```
Automatic Schedule:
>7 days a week
```

```
Automatic Schedule:
>Mon-Fri only
```

```
Automatic Schedule:
>Sat & Sun only
```

```
Automatic Schedule:
>Custom DayKey
```

Set the time, date and day of the week individually. Two complete options for each day: SUNDAY to SATURDAY and SUNDAY 2 to SATURDAY 2.

```
Monday
>On
Open: 08:00 am
Close: 06:00 pm
```

Each day has the ability to set a HOLD OPEN and CLOSE time.

```
Thursday 2
OFF<
Open: 06:00 am
Close: 05:00 pm
```

(Same as above) Each day has the ability to set a second HOLD OPEN and CLOSE time.

# GENESIS PROGRAMING

## MONITORED INPUT SETTINGS

### Monitored Input Options

OPTIONS: OPEN OBSTRUCTION, CLOSE OBSTRUCTION, PROGRAMMED MONITORED INPUTS:

Choices are: 10K (10,000 Ohms Resistance) or 2-Wire.

*(The Genesis board supports a maximum number of (2) OPEN, (2) CLOSED & (2) programmable inputs. Contact AutoGate if additional inputs are required).*

**WARNING: Monitored Input missing**  
See LED indicators for Monitored

Board is programmed for a "Monitored" Input and it is missing, gate will not operate until the monitored input is restored.

Open Obstruction:  
>Edge: 10K  
Beam: Off

**OPEN OBSTRUCTION:** You have (3) choices: OFF, 10K or 2-WIRE. You must have a minimum of (1) programmed at all times for UL325 Rev. 6 and up.

**WARNING! Obstruction**  
An intended Input or manual reset req'd. to restore use.

If your gate had an OPEN OBSTRUCTION event, the gate will stop and reverse to full close until the obstruction is cleared and an INTENDED INPUT (Access Control input, Loop Reset, etc., but not ~~NOT~~ the CLOSE TIMER) or a MANUAL INPUT on the control board resets your gate back to normal operation.

Close Obstruction:  
>Edge: Off  
Beam: 10K

**CLOSE OBSTRUCTION:** You have (3) choices: OFF, 10K or 2-WIRE. You must have a minimum of (1) installed and programmed at all times per UL325 Rev. 6 through latest editions. **CLOSE OBSTRUCTION DEVICES** are approved Beams and Edges only!

**WARNING! Obstruction**  
An intended Input or manual reset req'd. to restore use.

If your gate had a **DOUBLE CLOSED EDGE OBSTRUCTION** event, the gate will shut down in the OPEN position until the obstruction is cleared and an INTENDED INPUT (Access Control input, Loop Reset, etc., but not ~~NOT~~ the CLOSE TIMER) or a MANUAL INPUT on the control board resets your gate back to normal operation.

Prog Mon Input 1:  
>Open Edge 10K  
Prog Mon Input 2:  
Close Beam 2-Wire

**PROGRAM MONITORED INPUTS:** Additional INPUTS for additional monitored devices. Choices are: OFF, 10K: OPEN EDGE, OPEN BEAM, CLOSE EDGE & CLOSE BEAM  
2-WIRE: OPEN EDGE, OPEN BEAM, CLOSE EDGE & CLOSE BEAM.

**WARNING! Obstruction**  
An intended Input or manual reset req'd. to restore use.

If your gate had an OBSTRUCTION event, depending on the monitored device, the gate will shut down either in the OPEN or CLOSED position until the obstruction is cleared and an INTENDED INPUT (Access Control input, Loop Reset, other) or a MANUAL INPUT on the control board will reset your gate back to normal operation.

## INPUT OPTIONS

### Input Options

OPTIONS: INPUT 1 & 2

## GENESIS PROGRAMING

### MOTORED INPUT OPTIONS (cont.)

```
>Input 1 Mode:
Off
Input 2 Mode:
Utt
```

#### INPUT (1 & 2) MODES:

OFF

OPEN-Open command

CLOSE-Close command

Single Button-Open-Stop-Close-Stop

Reverse-Reverse command

Fire-Holds the gate Open (*will cause a FLASHING ALERT warning screen*)

Shadow-Shadow Loop input

Auto Open: Default is OFF-Skips the next days 7-Day Timer cycle commands

Hold Open-Opens gate: Holds open until input removed (*will cause a FLASHING ALERT warning screen*)

Emergency Secure-Gate will NOT open (*will cause a FLASHING ALERT warning screen*)

Emergency Close-(Custom programmed, contact AutoGate for this option)

Aux 1 Pulse-Pulses Auxiliary 1 contacts

Aux 1 Hold-Holds Auxiliary 1 contacts until triggered

Aux 2 Pulse-Same as Pulse 1

Aux 2 Hold-Same as Hold 1

```
WARNING! FIRE
SWITCH IS ENABLED.
Hold Stop and press
Jog/select to clear
```

```
WARNING! HOLD OPEN
IS ENABLED, gate
will not close
until released
```

```
WARNING! EMERGENCY
SECURE is enabled.
Gate will not OPEN
until released
```

```
>Input: Open/Close
Off
Input: Open Only
Utt
```

Open/Close Program: Programs the OP/CL PRM Input under P2 on the board to either an OPEN/CLOSE input or an OPEN only.

### AUXILIARY OUTPUT OPTIONS

Aux Output Options

OPTIONS: AUXILIARY RELAYS (A & B), OUTPUT (1 & 2), PROGRAMABLE LOCK

```
>Relay A Mode:
Off
Relay B Mode:
```

AUXILIARY RELAYS (A & B): Either relay can be set for a variety of functions:

OFF

Pulse on Open Limit

Pulse on Close Limit

Hold on Open Limit

Hold on Close Limit

Pulse on Motor Open

Pulse on Motor Close

Hold on Motor Open

Hold on Motor Close

```
>Output 1 Mode:
Hold on Aux 2
Output 2 Mode:
Off
```

OUTPUT (1 & 2): Either relay can be set for a variety of functions

OFF

Pulse on Open Limit

Pulse on Close Limit

Hold on Open Limit

Hold on Close Limit

Pulse on Motor Open

Pulse on Motor Close

Hold on Motor Open

Hold on Motor Close

Hold on UL Alarm

Hold on Motor Run

## GENESIS PROGRAMING

### AUXILIARY OUTPUT OPTIONS (cont.)

>Programmable lock:  
Magnetic

**PROGRAMABLE LOCK:** Output to control Maglocks or Solenoid Locks. The Maglock will be powered all the time and turn off prior to gate motion. The Solenoid mode will power a 24VDC output prior to gate motion.

### MAINTENANCE

Maintenance

**GATE ORIENTATION, BATTERY STATUS, SOLAR, BATTERY CHECK, BATTERY LEVEL, OVER CURRENT LEVEL, CONSTANT PRESSURE MODE, DUAL GATE MODE & CUSTOM SETTINGS**

>Gate Orientation:  
Right

**GATE ORIENTATION:** Set for LEFT or RIGHT hand gate. The hand is always determined from the INSIDE or PRIVATE side of the gate system. If the operator is located on the right-RIGHTHAND, left-LEFTHAND.

>Dual Gate Mode:  
>Off  
Status  
Disconnected

**DUAL GATE MODE:** Turn "ON" when you have (2) gates opening at the same time.  
Options: OFF, Primary or Secondary. If "ON", then each gate needs to be set accordingly  
**STATUS:** Disconnected or Connected

Dual Gate Mode  
Communication Test

In a PRIMARY/SECONDARY or DUAL gate mode system, if you lose communication between the two operators you will get this message.

Batt: Float Charge  
>PMR SUPPLY: Normal  
Batt V Check Freq:  
30 Cycles

**BATTERY STATUS:** Indicates the charging status:  
**FLOAT:** When battery is FULL voltage and not being charged  
**BULK:** Battery is in charging mode  
**ABSORPTION:** Batteries are low switches to **charging**.  
**POWER SUPPLY VOLTAGE:**  
**NORMAL (Default):** Standard power supply  
**CHARGE:** For retrofitting older systems only and replaces the original factory transformer  
**SOLAR:** Used when you have Solar Panels

**WARNING! If Solar is set to ON, and AC voltage is present, the AC voltage will not be connected and you will still be operating off batteries only!**

**BATTERY V CHECK:** How often the board will test the batteries under load. The factory pre-set is every 30 cycles. (Pass code required to change cycle frequency)

>Low Battery Action  
No Action

**LOW BATTERY ACTION:** Default is No Action  
Options are:  
**FAIL SAFE:** Gate will fail OPEN  
**FAIL SECURE:** Gate will fail CLOSED.

>Low Battery Level  
Note: this screen  
not viewable.  
Requires passcode

**BATTERY LEVEL:** During battery test, if the battery level falls below the level set, it will turn on the **FAULT LIGHT** and issue a **FAULT CODE**. (Passcode required to change). **(will cause a FLASHING ALERT warning screen)**

# GENESIS PROGRAMING

## MAINTENANCE (cont.)

**WARNING! LOW BATTERY**  
Check charge  
circuit, charge or  
replace batteries

Battery issue: Check the charge voltage, check the Batteries or replaced if necessary.

>Over-Current level:  
10 Amps

**OVER-CURRENT LEVEL:** Adjusts the Internal Inherent Amp current level for the motor. On model 2490 systems with the GENESIS board and the LPS SENSOR, this will not be in effect. When using **LIMIT SWITCHES**, the **OVER-CURRENT LEVEL** must be set for obstruction/entrapment sensing. If the board senses an **OVER-CURRENT** it will reverse the gate on the first activation. On a sequential activation, this will stop the gate and turn on the UL Alarm. To reset.... Check for any obstructions, if none, Press the **STOP** button on the board or if you have an accessory **STOP** button wired to the **STOP** input. The third option is to hit the **RESET** button.

>Const Press Mode:  
Off

**CONSTANT PRESSURE (CP) MODE (CLASS IV):** In the CP mode, the **OPEN 1 & CLOSE 1** inputs can be wired to a push button station for gate control. In a CP mode, these inputs will override the Entrapment **STOP/ALARM** condition. Status is **ON** or **OFF** only.

**WARNING!** Use caution when using these inputs. Always have direct line of site to the gate at all times to avoid pedestrian injuries or equipment/vehicle damage.

LOCKED  
Key: EB60F3CA  
-----

**CUSTOM SETTINGS:** For advanced features. Requires a "PASSCODE" available from AutoGate only. Code is active for 24 hours only. After 24 hours a new code is required.

## MOTOR CONTROL

Motor Control

**OPTIONS:** GATE SPEED, LIMIT SWITCHES, HALL (A & B), OPEN/CLOSE, POSITION SETTINGS

>Gate Opening Speed:  
100%  
Gate Closing Speed:  
100%

**GATE SPEED:** Default 100%, any percentage less than 100% down to 80% will slow the gate opening and closing down accordingly.

>Open Decel: 10  
Close Decel: 10

**DECEL SPEED:** Sets the time value on setting the gate speed from full speed to slow speed. The scale is 1 to 20, with 20 being the slowest.

>Limit Switches:  
Not Used

**LIMIT SWITCHES:** Default is "NOT USED". Model VPG 2490 systems are equipped with a Limit Position Sensor (LPS). *If no sensor is present, then a fault code is generated and the gate will not move.* Choices are: **NORMALLY OPEN, NORMALLY CLOSED, HALL & HALL B**. Normally open & close will choose the type of wired Limit Switch to be used.

**HALL A & HALL B:** Only used on direct replacements on **MEGA ARM** operators.

**WARNING! No Limit  
Position Sensor  
detected! Gate will  
not operate!**

## GENESIS PROGRAMING

### FAULT/LOGS/ALERTS

Fault/Logs/Alerts

OPTIONS: GATE SPEED, LIMIT SWITCHES, HALL (A & B), OPEN/CLOSE, POSITION SETTINGS

Fault Log  
>25 10:34p 04/20/18  
Gate Angle Sensor

**FAULT LOG:** Running list of faults, stored for reference for diagnostic troubleshooting. The last 99 codes are stored. The newest code will always be the first one shown. Any fault in the system will also turn on the **FAULT LIGHT** on the outside of the cabinet.

Operation Log  
#06< 02:55p  
06/29/18  
Local Open

**OPERATION LOG:** All normal "operations" are recorded up to 99 events. (i.e. entry inputs, loop detections, & photoelectric sensors/beam detections, traffic lights, etc. are examples of normal "operation" events logged.)

>Maintenance Alerts  
50K Cycles  
Next due at 80,000

**MAINTENANCE ALERT:** Alerts the owner that maintenance is due after a selected number of cycles. This can be set by installer for 10K, 20K or 50,000 cycles. The screen will show how long until the next alert will show. ***NOTE: WILL THERE BE SCREEN FLASHING TO ALERT FOR MAINTENANCE!***

>Maintenance Alert  
Maintenance required

**MAINTENANCE ALERT:** You have reached your predetermined number of cycles to perform general maintenance.



## GENESIS FREQUENTLY ASKED QUESTIONS (FAQ'S)

**Q.** What kind of power does the Genesis board run on?

**A.** The Genesis board runs from a 24 volt DC power supply and 24 volt battery back-up. Genesis can run directly off solar panels. The operator motor runs off the batteries and the Solar Panels will keep the batteries charged. The charging circuit is integrated on the board.

**Q.** How much accessory power is available?

**A.** The Genesis board has both 24 volt DC and 12 volt DC accessory power available. A total of 2 amps are available at 24 VDC. A separate 2 amps are available at 12 VDC.

**Q.** Where do I hook up NON-MONITORED Reversing devices such as Photo Beams and Reversing Edges?

**A.** All NON-MONITORED Reversing devices will be wired in the P2 terminals on the top righthand corner of the board. Refer to page 51 for details.

**Q.** Does Genesis have monitored inputs for "Entrapment Protection"?

**A.** Yes, there are 6 monitored inputs. Two dedicated inputs for the closing direction, (1-beam, 1-edge), and two dedicated inputs for the open direction, (1-beam, 1-edge). There are two fully programmable inputs that can function in either direction and for either type of device. These inputs are capable of monitoring 10K ohm devices. **Note: there must be at least one (1) device connected in both the open and close direction in order for the Drop arm/gate to operate. However, if you are using NON-MONITORED "Reversing" equipment, you will need to contact AutoGate for a PASSCODE to put your GENESIS board in a NON-MONITORED state for oper.**

**Q.** Is there a way to monitor the Drop arm/gate position, (Open or Closed)?

**A.** Yes, there are 2 Auxiliary relays on the board which can be used. Also there are 2 Auxiliary Outputs which can output 24 Volts DC to accessories when open and/or closed.

**Q.** Can the board control external devices, such as traffic lights, counters, and other options?

**A.** Yes, the 2 Auxiliary relays are programmable to trigger based on Drop arm/gate position and/or motion.

**Q.** Can the speed of the Drop arm/gate motion be controlled ?

**A.** Yes, the speed of the Drop arm/gate can be controlled separately in both directions. The adjustment will be from 100% to 75%.

**Q.** Why is the Green LED light flashing?

**A.** The green flashing LED signifies that the processor is powered up and working. If LED is on steady or OFF, the processor has a problem and the board needs replaced.

**Q.** System is completely dead and will not operate, how do I open the Drop arm/gate?

**A.** In a catastrophic failure (blown board, total power loss, etc.), pull the release handle on the bottom of the motor drive mechanism to disengage the drive coupler. Then at the Drop arm/gate, lift the Linkage Arm slightly upwards. The springs will start to pick the Drop arm/gate up. Then, push up on the bottom of the Drop arm/gate until fully open. Insert the T/M pin to lock open.

## GENESIS FREQUENTLY ASKED QUESTIONS (FAQ'S)

**Q.** Why won't my Drop arm/gate run in it is in programming mode?

**A.** This is a safety feature. Sudden Drop arm/gate motion while programming could cause a unintended reaction by the service technician that could lead to an injury. The only time the Drop arm/gate can move in program mode is during the program screen while setting Limit Switches. There is the ability to move the Drop arm/gate in minute increments by turning the JOG/SELECT knob while the "GATE" option is chosen on the screen.

**Q.** What is the difference between the "FAULT" log and the "OPERATIONAL" log?

**A.** The "Fault" log will store failures that are not part of standard operations. This includes things like no device connected to an active monitored input, or loss of voltage from the power supply, low battery voltage during the battery test, etc. The Operational log records all input actions, like the Open Input activation, or a monitored device is activated. This log also records the actions like close activation from the auto timer.

**Q.** Can I download the logs?

**A.** Yes, the logs will be available to down load by the USB port.

**Q.** My Drop arm/gate is not working, and a row of LED's is flashing?

**A.** The row of flashing LED's indicates the control board is in a programming mode and will not allow the Drop arm/gate to move. The control board will automatically cycle out of programming mode after 1 minute of no activity by the Jog/Select knob.

**Q.** What do I do if the "Main Power Loss / Low Battery" LED is flashing?

**A.** This LED is a multifunctional indicator. There are 3 flash rates that will display. If the LED is flashing, there is either a "Main Power" loss, a "Low Battery" condition, or a system fault. Open the outer cabinet door and look at the control board, a "Fault Screen" will display the current situation or fault.

**Q.** My Drop arm/gate closes too fast. How do I slow it down?

**A.** There are several possibilities:

1. The Drop arm/gate may be out of balance. Once the Drop arm/gate has been rebalanced or determined to be "In" balance, if necessary, the closing speed can be adjusted.
2. Adjust the slowdown time longer
3. Change the overall running speed of the Drop arm/gate in the closing direction

To access these adjustments will require a PASSCODE. Adjusting the "DECEL" rate shorter will slow the Drop arm/gate down sooner, thereby slowing the overall speed. To adjust the closing speed, access the screen showing the Drop arm/gate speed, which will have both Open & Close speed adjustable. The speed will be adjustable from 85% to 100% in 5% increments. Our recommendation would be to slow the Drop arm/gate down to 95% and test. This will normally be enough for most installations. If necessary, adjust to 90%.

## TROUBLESHOOTING THE GENESIS BOARD

Alarm is sounding and Drop arm/gate will not run	<ul style="list-style-type: none"> <li>• Drop arm/gate is in UL Alarm lock out – Press the “STOP” button to clear alarm; Verify there is no obstruction in the Drop arm/gate path. If alarm keeps coming on, rebalance Drop arm/gate and check OVER CURRENT setting.</li> </ul>
No power to control board	<ul style="list-style-type: none"> <li>• Verify power switches are “ON”.</li> <li>• Check 20 amp fuses on control board.</li> <li>• Check wires, connections at power supply, 10Amp fuse &amp; batteries.</li> </ul>
Drop arm/gate will not operate	<ul style="list-style-type: none"> <li>• Make sure Limit/Position Sensor (LPS) is connected and Genesis can see the signal.</li> <li>• Verify that there is at least one monitored device in both the open and close direction connected and operating correctly.</li> <li>• Check that both the batteries and power supply are on and the correct voltage is available to the board.</li> <li>• Check wiring connections at the motor; verify they are clean and tight.</li> <li>• Make sure the motor manual operation release disconnect is engaged for operation.</li> </ul>
Drop arm/gate starts to move then stops and/or reverses	<ul style="list-style-type: none"> <li>• Check fault Log</li> <li>• Verify motor over current value is set properly.</li> <li>• Check and adjust Drop arm/gate balance.</li> <li>• If Drop arm/gate reverses when closing, check for any input activation.</li> <li>• If Drop arm/gate reverses when opening, check for any “Open Entrapment” input activation.</li> </ul>
Drop arm/gate will not close	<ul style="list-style-type: none"> <li>• Check Fault log</li> <li>• Check operation inputs for activation, clear as necessary.</li> <li>• Verify “Close Monitored Inputs” are connected properly and functional.</li> <li>• Check for Reversing or Free Exit loop or detector fault.</li> <li>• Clear “HOLD OPEN” or “FIRE INPUT” command.</li> </ul>
Drop arm/gate will not open	<ul style="list-style-type: none"> <li>• Verify “Open Monitored Inputs” are connected properly and functional.</li> </ul>
Drop arm/gate opens, will not time out to close	<ul style="list-style-type: none"> <li>• Verify “Auto Close” is on.</li> <li>• Use “Close” command to close Drop arm/gate. If Drop arm/gate closes, Drop arm/gate was in second close edge obstruction and was awaiting an input to activate motion.</li> </ul>
Batteries will not charge up	<ul style="list-style-type: none"> <li>• If running on the AC Power Supply, make the board is not set for SOLAR operation. Verify that the power supply has an output voltage of <math>26.5 \pm .5</math> volts.</li> <li>• If running on SOLAR panel(s), make sure board is set for SOLAR operation. Verify the panel(s) have an output greater than 31 volts DC.</li> </ul>
Red LED light on side of Cabinet is flashing	<ul style="list-style-type: none"> <li>• The RED LED is a warning light. If flashing, indicates a fault or failure.</li> <li>• Fast Flash – Low Battery</li> <li>• Double Pulse Flash – Main Power input Missing</li> <li>• Slow Flash – Fault or UL Alarm</li> </ul>

## ACCESSORY COMPONENTS

### Accessory Components

If your system came with accessory or optional components that require installation or setup, you must review this section for Operator Wiring & Testing and instructions provided by the component manufacturer. In general, those instructions provide guidance needed for installing and using these accessory components.

The following table lists the accessory components that may have been provided with your system.

#### Accessory (Optional) Components

Component or System	Comments
<p><b>Note:</b> Certain components should be considered mandatory on all active vehicle barrier systems. These are noted below and should be procured, installed, and tested before the system is commissioned and used by the owner.</p>	
Vehicle Loops & Loop Detectors	These are required to restrict or limit gate operation under certain vehicle detection or in conjunction with access control station vehicle presence detection. A socket for the loop detector electronic control modules are pre-installed in the electrical enclosure. Installer must fabricate and install loops in the roadway, install the control module (detector), complete the hookup, and program/adjust detector sensitivity for good interaction of the loops and the barrier system.
Infrared Photo Electric Sensors	Used to stop and reverse the Drop arm/gate when closing. If an object passes through or blocks the beam, the Drop arm/gate will remain open while the beam is blocked.
Traffic Signal Lights—1 lens, 2 lens, or 3 lens (Ex: Red, Yellow, Green)	Used to warn of the barrier systems presence and operation. AutoGate recommends an 8" Red LED lens at all times, except when the Drop arm/gate is in its fully open position, in which case we recommend a Yellow (amber) flashing lens.
Warning Signs, Reflective Tape, Warning Lights	Drivers should be alerted to the presence of a high-stopping power barrier system, and that striking the barrier will cause injury or death. Speed limits should also be posted. Contact AutoGate for specific Warning Signs, reflective tape, & Warning Lights that can be affixed to the Drop arm/gate.

# MAINTENANCE OPERATOR DETAILS

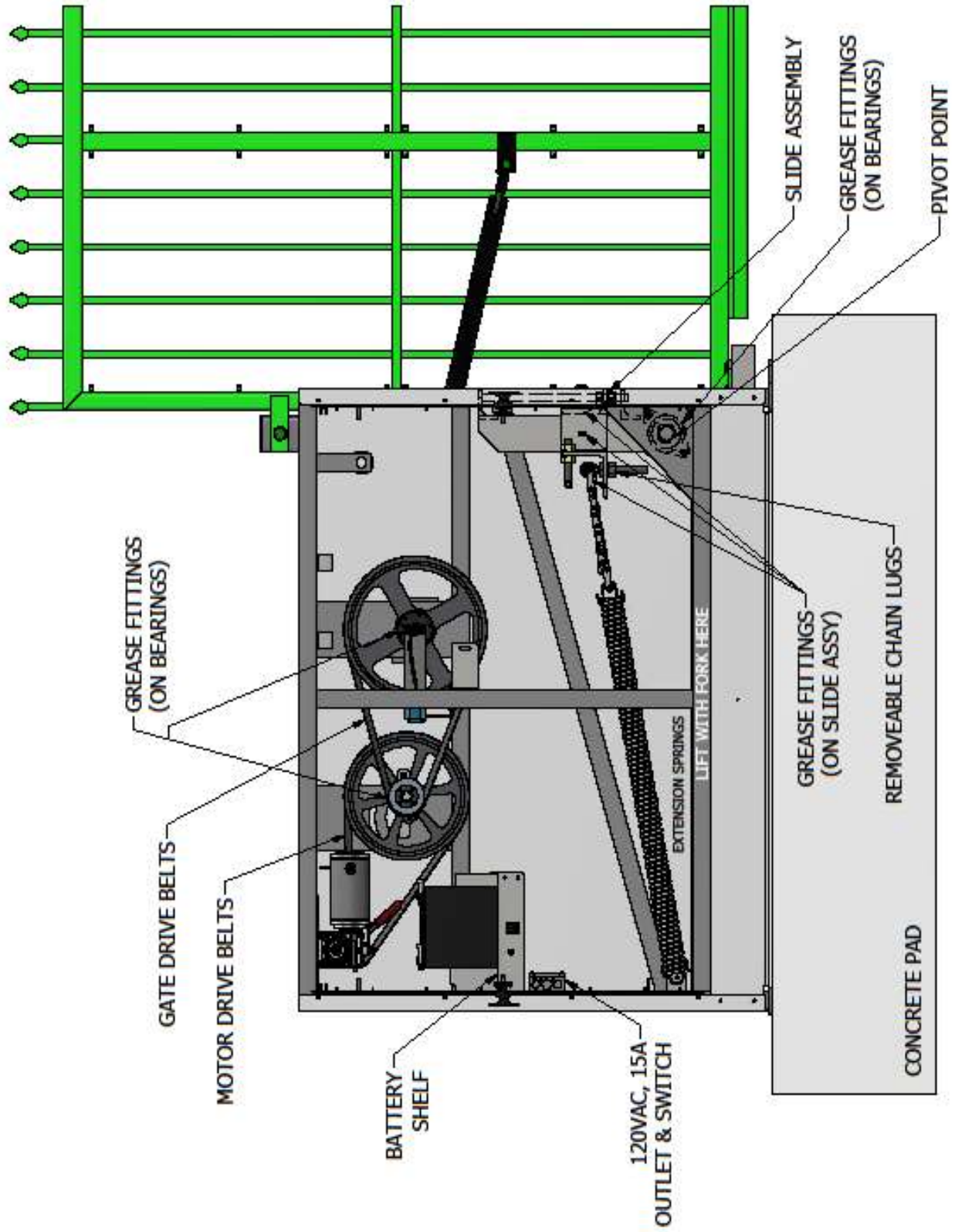

GREASE FITTINGS (ON BEARINGS)

GATE DRIVE BELTS

MOTOR DRIVE BELTS

BATTERY SHELF

120VAC, 15A OUTLET & SWITCH

EXTENSION SPRINGS

LIFT WITH FORK HERE

GREASE FITTINGS (ON SLIDE ASSY)

REMOVEABLE CHAIN LUGS

SLIDE ASSEMBLY

GREASE FITTINGS (ON BEARINGS)

PIVOT POINT

**ELEVATION VIEW**

## MAINTENANCE

The basic electrical and mechanical systems require only minimum routine maintenance. The following items should be checked and serviced periodically depending on amount of use. Each item below has supporting illustrations and/or instructions in this manual. Contact AutoGate for any questions or issues. **Maintenance is important to any Drop arm/gate system and can affect safety, warranty, quality operation, and life-cycle of the system.**

**REFER TO OPERATOR DETAILS PAGE 10 AND MAINTENANCE OPERATOR DETAILS ON PAGE 43**

ITEM	RECOMMENDED MAINTENANCE
Grease Linkage Assembly ("LUBRIPLATE 'R' LOW TEMP" Grease)	10,000 cycles or 6 months
Grease all bearings: two (2) Operator Arm, four (4) Bullwheel Shafts	10,000 cycles or 6 months
Grease Chain Tension Bolt and Lube Chain & lightly coat springs (Use a non-evaporating cable and chain spray)	10,000 cycles or 6 months
Check belts for wear and tightness. (See page 44 for instructions)	Every 6 months
Charge voltage for batteries should be 27.5 VDC with batteries disconnected check at battery in maintenance menu.	Every 6 months
Check battery water level, use distilled water only (Not required on maintenance-free or AGM style batteries)	Every 6 months
Clean snow/ice off of gate (Balanced correctly, gate will temporarily tolerate an additional 10 lb. of wt.)	As needed
Clean lenses on Photoelectric sensors/beams or Reflectors	As needed
Lubricate (Graphite Oil) all door latch, lock cylinders and mechanisms	Every 6 months
Check and verify proper operation of all <b>External monitored</b> entrapment protection devices. See page 22 and the external entrapment protection device (s) manufactures instructions.	Every month
Check and verify proper operation of the <b>Internal</b> (TYPE A) entrapment protection device (LPS) by walking to the middle to end of the gate and stop the gate, it should reverse.	Every month
Check gate balance (see page 46)	Four months after install, then annually
Check to make sure all WARNING signs are still displayed	Every month

## SPRING CHANGING INSTRUCTIONS

**WARNING:** SPRINGS ARE UNDER A TREMENDOUS LOAD. TAKE EXTREME CAUTION WHEN REMOVING AND REPLACING THEM.

### STEPS:

1. For ease of access, remove the door and end panel nearest the Drop arm/gate.
2. Disable the photoelectric sensor/beam if equipped.
3. Remove any upper "T" bolts completely and loosen the slide assembly screws.
4. Loosen the top adjusting nut of the slide assembly. Thread the nut up to within four (4") inches of the top of slide mechanism.
5. You will now raise the Drop arm/gate. (**DO NOT** release the disengage lever!) Initiate the Drop arm/gate to open, immediately move to the Drop arm/gate and help raise it open, once the slide moves up, hold on the bottom rail of the Drop arm/gate until fully open. The Drop arm/gate may bounce slightly, there will be a loud bang but no damage will occur.
6. Turn Off AC/DC Power before Drop arm/gate "times out" and tries to close. Insert T/M Pin.
7. Using a 1 5/16 wrench, loosen and remove the chain tension bolt with the damaged spring.
8. Replace damaged spring
9. Replace chain tension bolt. **NOTE:** Grease fitting must point down! Tighten bottom nut. **NOTE:** Chain **MUST** remain level and not twisted once tightened.
10. Remove T/M pin and restore AC/DC power.
11. Lowering the Drop arm/gate. Initiate the Drop arm/gate to close and at the same time, assist the Drop arm/gate down by pulling on the bottom rail of the Drop arm/gate. The slide will move down and another loud bang as the Drop arm/gate is lowered.

13. Thread the slide nut back down to the slide assembly and tighten.
14. Replace the T-Bolts to their original location and tighten and tighten the slide assembly screws.
15. Restore AC/DC power and hook photoelectric sensor/beam back up.
16. Cycle Drop arm/gate.
17. Spray all springs with a chain lube to prevent corrosion.
18. Grease Chain Tension bolts, Linkage Arm & Bearings

**RECOMMENDED:** Always check and adjust the balance after any spring change. Refer to balancing instructions at [www.AutoGate.com](http://www.AutoGate.com) or

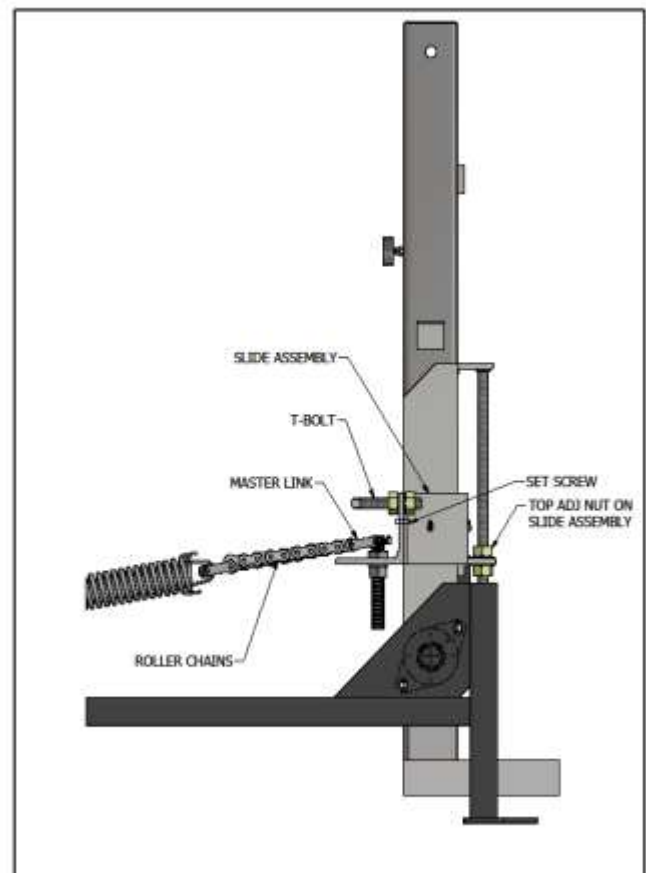

# BALANCING

## TESTING AMPERAGE:

1. CONNECT AMP METER IN SERIES BY REMOVING THE WIRE NUT FROM THE RED MOTOR LEAD.
2. CYCLE GATE UP AND DOWN RECORDING THE HIGHEST AMPERAGE IN THE SPACE PROVIDED, AND ADJUST IF NECESSARY. HIGHEST UP & DOWN READING SHOULD NOT EXCEED 1 AMP DIFFERENCE. FOR EXAMPLE: IF YOUR HIGHEST READING IS 6.5 IN THE UP, AND THE HIGHEST READING IN THE DOWN WAS 8.0... THAT WOULD BE ACCEPTABLE. UN-ACCEPTABLE WOULD BE 3.0 IN THE UP AND 8.1 IN THE DOWN.
3. LOOSEN ADJ. 1/8" NUTS ON BOTH SIDES OF THE SLIDE ASSEMBLY ANGLE.
4. ONLY ADJUST 3 TO 4 TURNS (1/4") AT A TIME AND CHECK YOUR AMPS. AFTER EACH ADJUSTMENT. NOTE: YOUR AMPS. UP, OPENING, SHOULD BE AT LEAST 1/2 (5) AMPS LOWER THAN YOUR AMPS. DOWN, CLOSING.
5. IF GATE OPENS SLOW, RAISE THE SLIDE ASSEMBLY. IF GATE WILL NOT CLOSE, LOWER THE SLIDE ASSEMBLY. IF GATE STALLS IN EITHER DIRECTION, YOU OVER-ADJUSTED. BACK OFF YOUR LAST ADJUSTMENT AND CHECK AMPS.
6. IF GATE IS SLOW TO CLOSE FROM THE OPEN POSITION, INCREASE LENGTH OF T-BOLT.

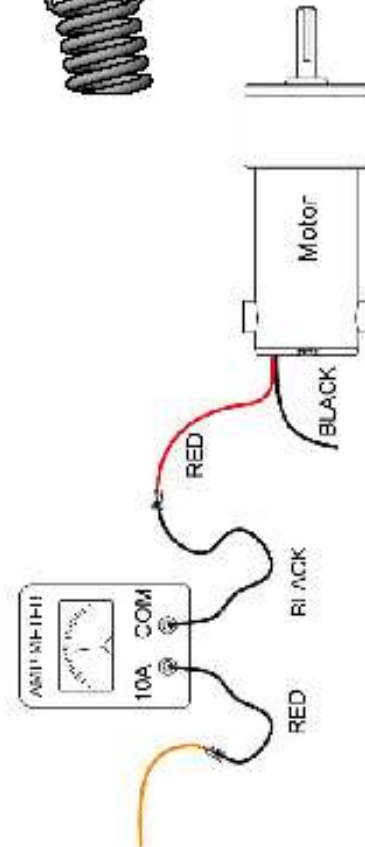
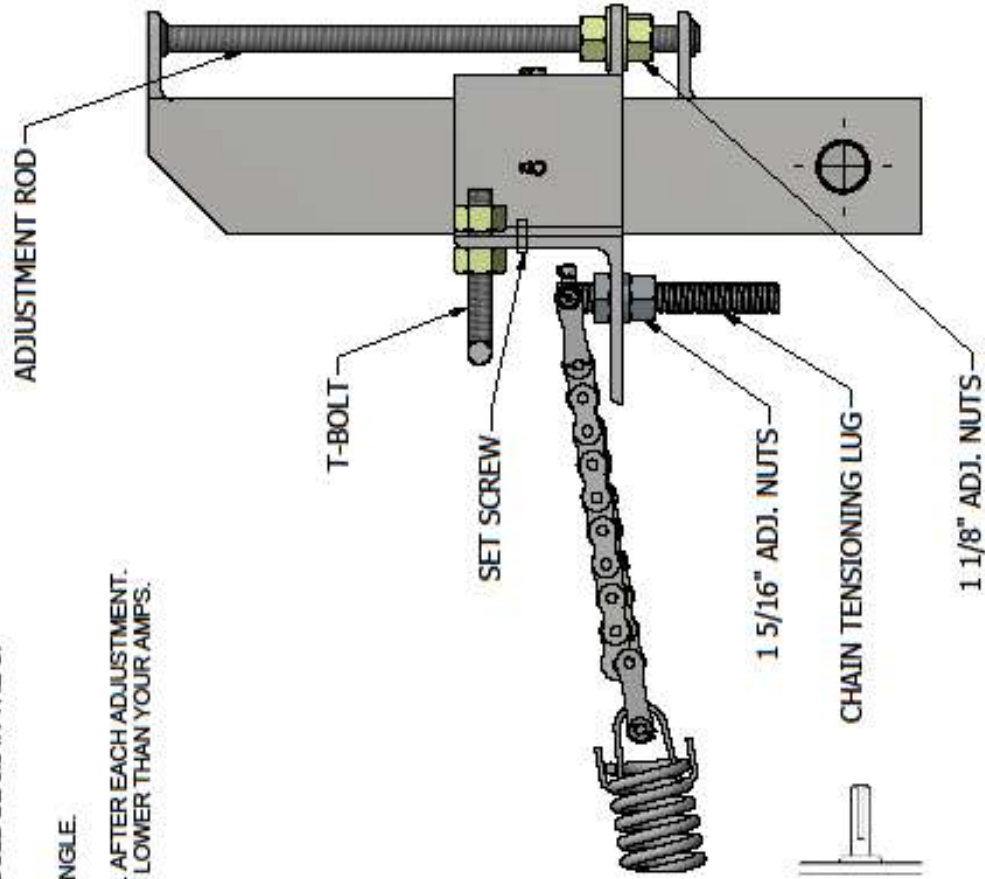

UP: 10% 55% 85%

Down: 10% 55% 85%



## BELT CHANGING INSTRUCTIONS

Changing the belts on an AutoGate Vertical Pivot operator is easy by following the step by step procedure outlined below. As always, we are only a phone call away should you need assistance at 800-944-4283.

1. Remove the **(4) Tek Screws** on the **Top Panel** using a 5/16" nut driver, remove and set aside.
2. Remove the **STIFFENER PLATE (#1)** from the **POSITION SENSOR bracket**. This allows a space to remove belts.
3. Release the **MOTOR DRIVE BELT (#2)** tension by loosening the **(4) 3/8" CARRIAGE BOLT nuts** securing the **GEAR MOTOR bracket (#3)** to the **SIDE SLIDE plates (#4)** with a 9/16" wrench. Now using a 9/16" wrench, back off the **(2) Gear Motor FORCING screws (#5)** so that only 1" remains through the coupling nut.
4. Slide the **GEAR MOTOR assembly** to create slack in the belts.
5. On the center of the pulleys. Loosen the **FLANGE BEARING bolts (#6)** about one turn that secure the shaft bearings using a 15/16" wrench.
6. Loosen the **MIDDLE FORCING screw (#7)** which is applying tension on the **DROP ARM/GATE DRIVE belts (#8)** by using a 15/16" wrench. This too needs to be fully loosened to allow enough room to remove the belts.
7. Remove old belts and install new belts loosely.
8. Apply snug pressure to the **MOTOR DRIVE belts** by using the **(2) GEAR MOTOR FORCING screws**. This should also snug the **DROP ARM/GATE DRIVE belts**. *Do not overtighten!*
9. Thread the **MIDDLE FORCING screw** to finger tight.
10. Re-Assemble the **STIFFNER PLATE** to the **POSITION SENSOR bracket**.
11. Operate the Drop arm/gate up and down for (5) time to seat the belts.
12. Tighten the **MIDDLE FORCING screw** to tighten the **DROP ARM/GATE DRIVE belts**. Correct tightness is 10lbs. of pressure applied at the center of belts with a 1/2" deflection.
13. Tighten the **FLANGE BEARING bolts** on the middle set of pulleys.
14. Tighten the **GEAR MOTOR FORCING screw** to achieve 1/4" deflection with 10lbs. of pressure applied at the center of the belts.
15. Tighten the **(4) CARRIAGE bolts** to secure the **GEAR MOTOR bracket** to the **SIDE SLIDE plates**.
16. Operate the Drop arm/gate up and down 5-10 times to check for proper operation.
17. Replace the **Top Panel** using the (4) Tek screws.

## BELT TIGHTENING INSTRUCTIONS

- |                     |                              |
|---------------------|------------------------------|
| 1. Stiffener Plate  | 5. Gear Motor Forcing Screws |
| 2. Motor Drive Belt | 6. Flange Bearing Bolts      |
| 3. Gear Motor       | 7. Middle Forcing Screw      |
| 4. Side Slide       | 8. Gate Drive Belts          |

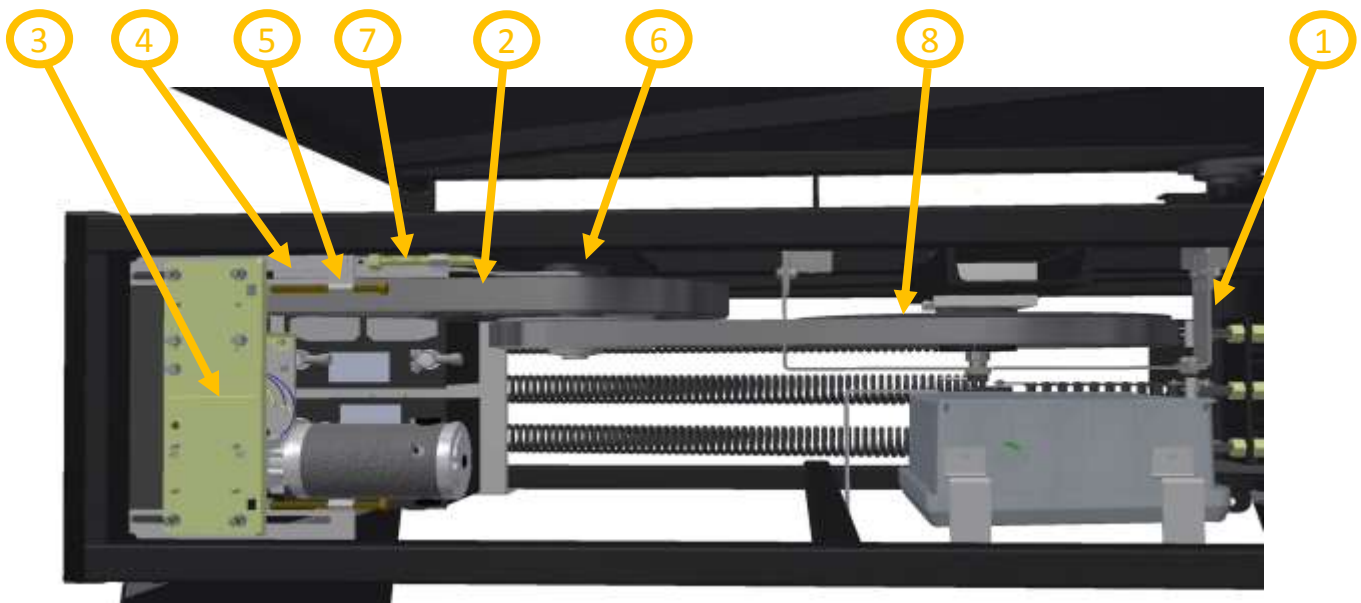

# SHIELD POST INSTALLATION CHECKLIST

*One copy to remain with End User, one to remain with Installer, one to be sent to AutoGate.*

Date Installed: \_\_\_\_\_ AG#: \_\_\_\_\_ Serial #: \_\_\_\_\_

Site Location: \_\_\_\_\_

Customer Name: \_\_\_\_\_ Phone: \_\_\_\_\_

Contact Name: \_\_\_\_\_ Mailing Address: \_\_\_\_\_

Date Inspected: \_\_\_\_\_

**1. Foundation**

1.1 Concrete Foundation to Spec and Instructions Checked  Initials \_\_\_\_\_

Concrete foundation with rebar mats poured to specifications.

Concrete foundation measurements:

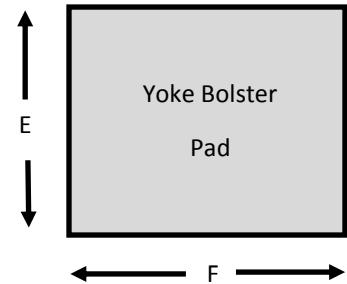
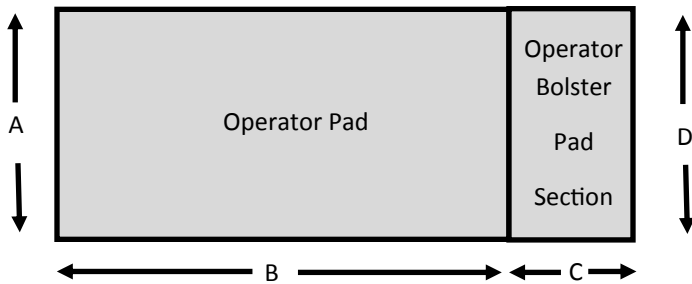

A: \_\_\_\_\_ ft \_\_\_\_\_ in    B: \_\_\_\_\_ ft \_\_\_\_\_ in    C: \_\_\_\_\_ ft \_\_\_\_\_ in    D: \_\_\_\_\_ ft \_\_\_\_\_ in

A: \_\_\_\_\_ ft \_\_\_\_\_ in    B: \_\_\_\_\_ ft \_\_\_\_\_ in

# SHIELD POST INSTALLATION CHECKLIST (con't.)

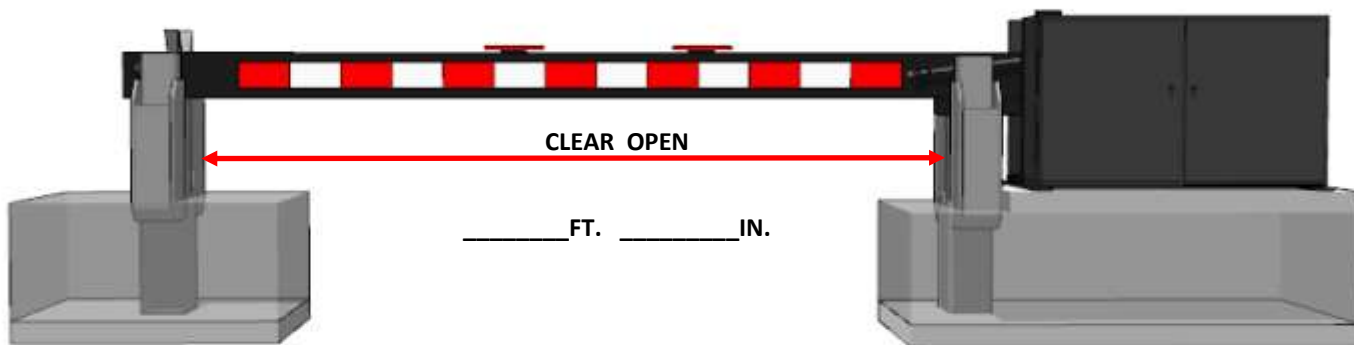

2. Clear Open. Fill in both feet and inches above.

3. Safety: Check for the following:

- Customer advised the Shield is for vehicular traffic only. Separate pedestrian entry gate and walkway.
- Set and tested Internal Entrapment operation.
- Warning placards placed in clear view on both sides of the Drop arm/gate (do not drill into Arm).
- Installed and verified external entrapment sensors (photo eye(s) and contact sensors).
- Installed the Drop arm/gate guard to the back of the operator or fenced off this area restricting pedestrians from standing in or entering this entrapment area.
- All access controls are a minimum of 6 ft. away from any system component (operator, bolsters, Ddrop arm/gate, gate, gate guard, etc.).
- Identify any area a pedestrian or owner can be struck, entrapped, pinched, etc by this system and take actions to mitigate injury through placement of entrapment protection means outlined in this manual.

4. Electrical

4.1. Measure Input Voltage Checked  Initials: \_\_\_\_\_

Single Phase: Check all that apply.  120V  208V  230V  50 Hz  60Hz

4.2. Grounding Checked  Initials: \_\_\_\_\_

- NFPA 780 Standard for the Installation of Lightning Protection Systems.
- Solid copper ground rod: (5/8in diameter, 10ft length) driven into ground within 3ft of operator.
- Single length of un-spliced 6AWG Copper wire less than 3ft long attached to lug on operator frame.

5. Accessories: Proper installation and operation of any lights, alarms, emergency access, heat mats, etc.

Checked  Initials: \_\_\_\_\_

Notes or comments: \_\_\_\_\_  
\_\_\_\_\_  
\_\_\_\_\_

## SHIELD POST INSTALLATION CHECKLIST (con't.)

6. Loops and Loop Detectors Checked  Initials: \_\_\_\_\_
- Loops installed per manufacturers instructions and project plans and specifications.
  - Test loop resistance with Ohm meter. Note measured resistance level: \_\_\_\_\_
  - Test vehicle detection with vehicle(s).
  - Note Loop Detector(s) used. Manufacturer: \_\_\_\_\_ Model: \_\_\_\_\_
7. Mechanical and End User Training/Demonstration. Performed  Initials: \_\_\_\_\_
- Photo Eyes (if used) cause Drop arm/gate to stop and reverse.
  - Contact Sensors (if used) cause Drop arm/gate to stop and reverse.
  - Test the Inherent Entrapment system.
  - Instruct End User on all external lights, control board lights, and Genesis LCD screen indicators.  
Demonstrate how to reset the system.
8. Miscellaneous Performed  Initials: \_\_\_\_\_
- Kick Panel installed on Door side of operator
  - Debris Shield (if ordered) installed in the back of operator
  - Any field wiring is secured, protected from the weather, and protected from pinching or mechanical strikes.
9. Photographs and Checklist Submittal. Performed  Initials: \_\_\_\_\_
- Photos taken of the system with Drop arm/gate open and Drop arm/gate closed.
  - Photos taken from Secure side and Public side.