

MONTAGE II[®]

INDUSTRIAL ORNAMENTAL STEEL FENCE



AMERISTARFENCE.COM | 888-333-3422

Experience a safer and more open world

AMERISTAR[®]

ASSA ABLOY



STRENGTH & BEAUTY

SECURITY HAS NEVER BEEN MORE ELEGANT

Manufactured for strength with a penchant for beauty, *Montage II* is an *industrial grade steel fence* that delivers on all levels. *Superior welding* techniques create a profile that lends itself to *stylish design* while sustaining a level of unmatched security through *all-terrain flexibility*. *Sophisticated protection* is the simplest way to describe the Montage II perimeter security fence system.





Primary applications for Montage II ornamental steel fence systems include:

- ⇨ Stadiums*
- ⇨ Water Districts*
- ⇨ Public Housing*
- ⇨ Railway*
- ⇨ Multi-Family Housing*
- ⇨ Self-Storage*
- ⇨ Assisted Living*
- ⇨ Municipal*
- ⇨ Institutions*
- ⇨ Manufacturing*
- ⇨ Parks & Recreation*

MONTAGE II[®]

INDUSTRIAL ORNAMENTAL STEEL FENCE

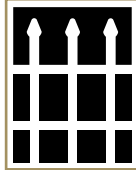

CLASSIC[™]

TIMELESS & ELEGANT

Extended pickets that culminate to an *arrow-pointed spear* capture the look of old style wrought iron fencing. *Single or double swing & slide gates* that perfectly match this fence style are also available.

- 4-rail panels | 6', 7' & 8' heights | flush bottom or extended picket
- 3-rail panels | 3', 3½', 4', 5', 6', 7' & 8' heights | flush bottom or extended picket
- 2-rail panels | 3', 3½', 4', 5', 6', 7' & 8' heights | flush bottom or extended picket

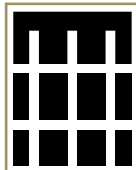

GENESIS[™]

PERSONALIZED & SECURE

Extended flat-topped pickets serve as a base for your choice of accent finials providing a customized design. *Single or double swing & slide gates* that perfectly match this fence style are also available.

- 4-rail panels | 6', 7' & 8' heights | flush bottom or extended picket
- 3-rail panels | 3', 3½', 4', 5', 6', 7' & 8' heights | flush bottom or extended picket
- 2-rail panels | 3', 3½', 4', 5', 6', 7' & 8' heights | flush bottom or extended picket

ADORNMENT OPTIONS

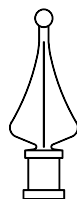

QUAD FLARE



TRIAD



ROYALTY

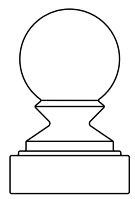

BALL POST CAP

1"sq. x 14ga. PICKETS | 1.75" x 1.75" x 12ga. RAILS | 2.5"sq. x 12ga. / 3"sq. x 12ga. POSTS



MAJESTIC™

SLEEK & MODERN

The *flush top rail* projects a more *modern*, streamlined look that beautifully accents flowers and shrubs when used as border landscaping. *Single or double swing & slide gates* that perfectly match this fence style are also available.

- 4-rail panels | 6', 7' & 8' heights | flush bottom or extended picket
- 3-rail panels | 3', 3½', 4', 5', 6', 7' & 8' heights | flush bottom or extended picket
- 2-rail panels | 3', 3½', 4', 5', 6', 7' & 8' heights | flush bottom or extended picket

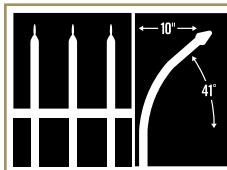

INVINCIBLE™

INTREPID & FORTIFIED

Pickets curve outward gracefully with a duality that acts as an attractive yet *visually intimidating* deterrent. *Single or double swing & slide gates* that perfectly match this fence style are also available.

- 4-rail panels | 7' & 8' heights | flush bottom or extended picket
- 3-rail panels | 3½', 7' & 8' heights | flush bottom or extended picket
(3½' panels available with flush bottom rail only)
- 2-rail panels | 3', 3½', 7' & 8' heights | flush bottom or extended picket

COLOR OPTIONS

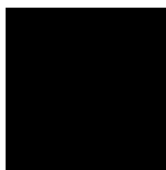

BLACK



BRONZE



E-COAT™

Major corrosion problems start from the inside. That's why all products in the Montage® family are **COATED INSIDE & OUT**. Our **GALVANIZED STEEL FRAMEWORK** is subjected to a **MULTI-STAGE PRE-TREATMENT/WASH**, followed by a **DUPLEX CATHODIC ELECTROCOAT SYSTEM** consisting of an **EPOXY PRIMER**, which significantly increases corrosion protection, and an **ACRYLIC TOPCOAT**, which provides the protection necessary to **WITHSTAND ADVERSE WEATHERING EFFECTS**.

PRE-TREATMENT



**ALKALINE
SPRAY WASH**

1



**ALKALINE
IMMERSION**

2

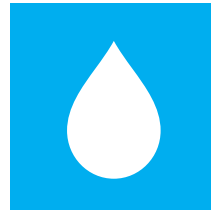

**WATER
IMMERSION**

3

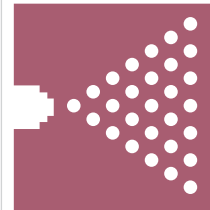

**SPRAY
CONDITIONER**

4



**PHOSPHATE
IMMERSION**

5

EPOXYPROCESS



**ELECTRO COAT
EPOXY PRIMER**

10

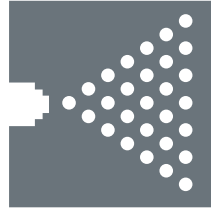

**PERMEATE
SPRAY RINSE**

11



**PERMEATE
IMMERSION**

12

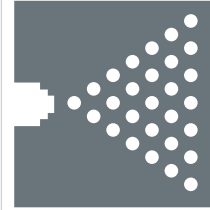

**PERMEATE
SPRAY RINSE**

13



**REVERSE OSMOSIS
HALO RINSE**

14

ACRYLICFINISH



**ELECTRO COAT
ACRYLIC PRIMER**

17

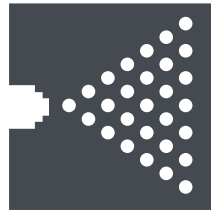

**PERMEATE
SPRAY RINSE**

18



**PERMEATE
IMMERSION**

19

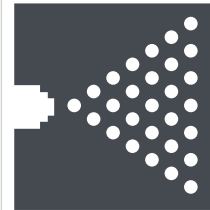

**PERMEATE
SPRAY RINSE**

20



**REVERSE OSMOSIS
HALO RINSE**

21

**WATER
IMMERSION**

6



**NON-CHROMATE
SPRAY SEAL**

7

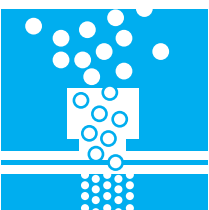

**REVERSE OSMOSIS
IMMERSION**

8



**REVERSE OSMOSIS
HALO RINSE**

9

Immersion processes coat & cleanse the inside of the fence components as thoroughly as the outside. This prevents corrosion giving Montage II products the ability to withstand the elements & be maintenance free.



**FINISH CURING
OVEN**

15



**COOLING
TUNNEL**

16



**FINISH CURING
OVEN**

22



**COOLING
TUNNEL**

23



LAYERED PROTECTION

*Protection against corrosion starts with a proven process, which is why Ameristar emulated its PermaCoat method to develop a superior E-Coat process that protects the product with complete coverage **INSIDE & OUT***

-  *Acrylic Topcoat*
-  *Epoxy Primer*
-  *Phosphate*
-  *PreGalvanized Steel*

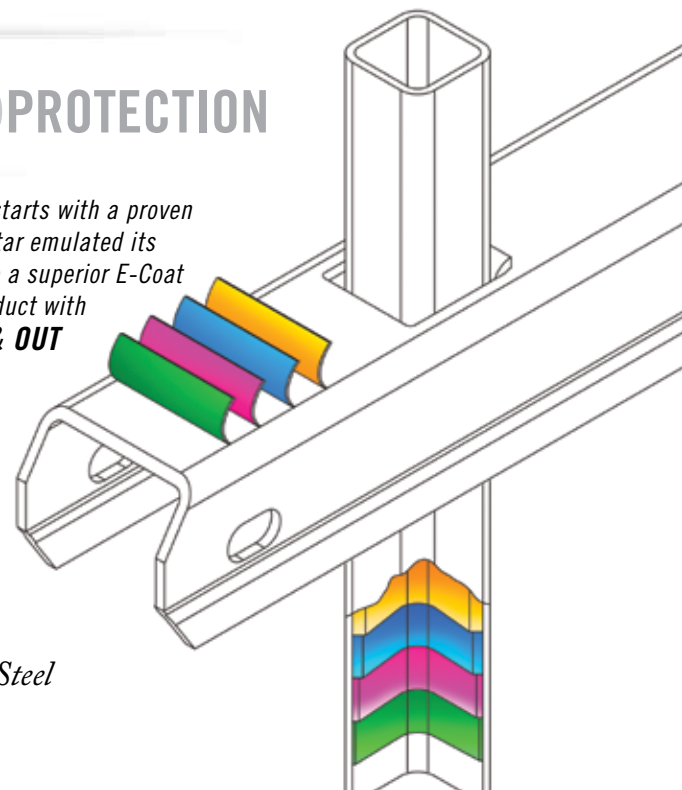

PROFUSION WELDING

Montage II fence panels are fabricated through a **WELDING TECHNIQUE** that combines laser and fusion technology to create a virtually **INVISIBLE STRUCTURAL CONNECTION** at every picket to rail intersection. Unlike typical fence systems that are held together with unsightly screws, the ProFusion weld champions a “good neighbor” profile with sleek lines and **NO EXPOSED PICKET TO RAIL FASTENERS**. When compared to traditional decorative fencing, the Montage welded steel construction is unmatched in strength and durability.



PANEL BRACKET

Universal Boulevard Bracket enables easy installation while allowing for adjustment of panel height and positioning

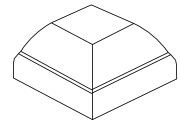

SECURITY FASTENERS

Security fastener secures the rail and deter removal by typical tools

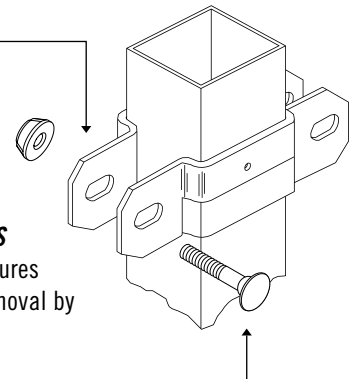



PICKET TO RAIL PROFUSION WELDING

Each picket is welded precisely at each rail connection for ease of installation yet remaining flexible as an all terrain fence

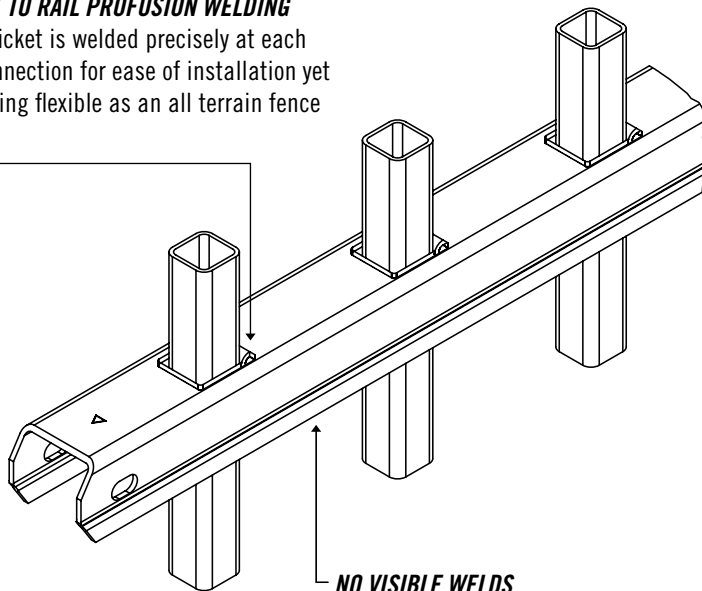

NO VISIBLE WELDS

Profusion welding techniques are both strong and hidden from view providing a good neighbor profile

INCREASED SECURITY

Crafted from industrial grade steel, and precision welded by ProFusion techniques makes Montage II the best choice for perimeter security fencing.

AESTHETIC DETAILS

Montage II is manufactured not only for strength but also elegance. Featuring a “good neighbor” profile with no visible welds or screws, each picket to rail connection is concealed for visual appeal.

RAKEABLE VS STAIR-STEP

The ProFusion welded picket to rail connection is the method used to construct Montage II panels, which allows a minimum biasability of 25%, eliminating unsightly stair stepping of panels.

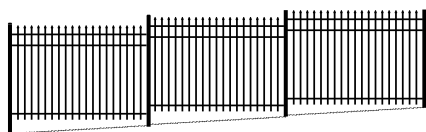

Stair-stepping panels

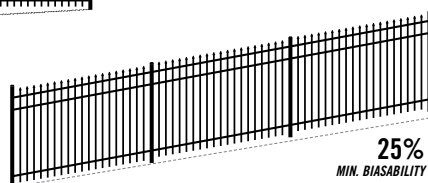

Fully rakeable panels

PEACE *of* MIND



Ameristar's Montage II fence systems are backed by over 30 years of excellence in the fencing industry

Buy AMERICAN



Ameristar Fence Products is committed to providing products that meet the Buy American Act.

BEING GREEN



Ameristar products have the opportunity to earn LEED points.

ARCHITECTURAL SUPPORT & SOLUTION SPECIALISTS



*Ameristar's **Project Solution Specialists** are experienced in every facet of perimeter security design. Our goal is to assist the architectural community in finding the **best perimeter & entry solutions** for their projects. Ameristar's extensive library of project photos, CAD drawings, architectural specifications & project budget quotes are just a few of the services **our team offers to complete your project design.***

SLIDE GATES & SWING GATES

Egress & ingress requirements are unique to each application. *Managing traffic flow & usage demands* are of the utmost importance, which is why Montage II is manufactured in a variety of gate types built to *balance function, security & beauty*.

Ameristar *Transport™* & *Passport™* sliding gates perfectly match the perimeter fence system to create a *seamless & stunning design* while exuding a *commanding presence* of security built to unite perimeter and entry.

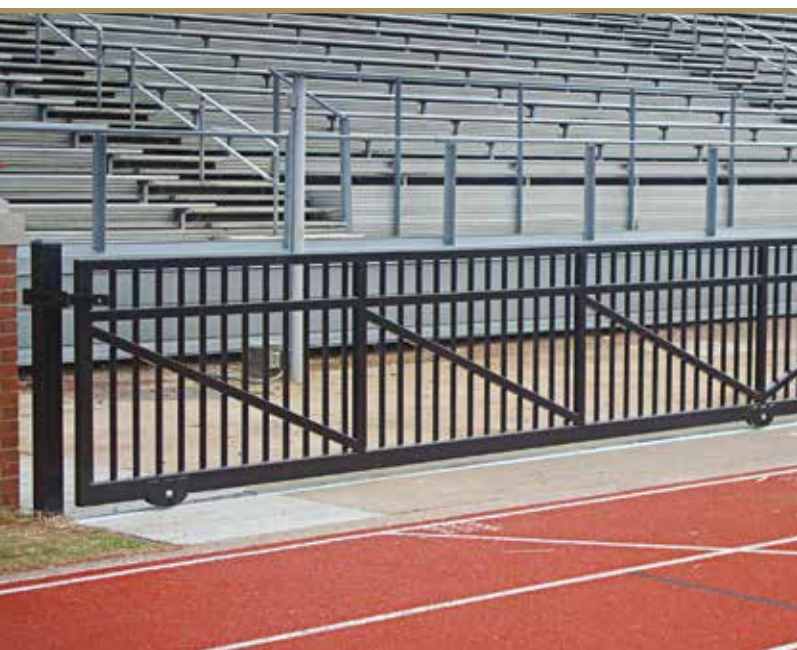

WHY CHOOSE AMERISTAR

► KNOWLEDGE & EXPERIENCE

Ameristar was chartered over *30 years ago* in response to the *demand by consumers & specifiers for specialty fence products*. Ameristar offers an *aesthetically pleasing product* that is both *high in quality & affordability*. This has been achieved by maximizing *high-volume productivity*, increasing product design strength, and promoting *simplistic installation*.

► PROVEN CAPABILITY

Ameristar's integrated *in-house process & extensive raw material inventory* results in much improved productivity and availability compared to the competition. By having a *vast finished goods inventory*, Ameristar is capable of *delivering finished products faster* than competitors who sublet the majority of their operations.

► INDUSTRY LEADERSHIP

Over the years Ameristar has continually *raised the bar* across the board in the *manufacturing of high quality*, innovative fencing products. Our demonstrated commitment to *upholding higher values* translates into superior products that *go far beyond* merely meeting minimum industry standards.



Ameristar's world headquarters, manufacturing & coil processing facilities in Tulsa, Oklahoma, USA.

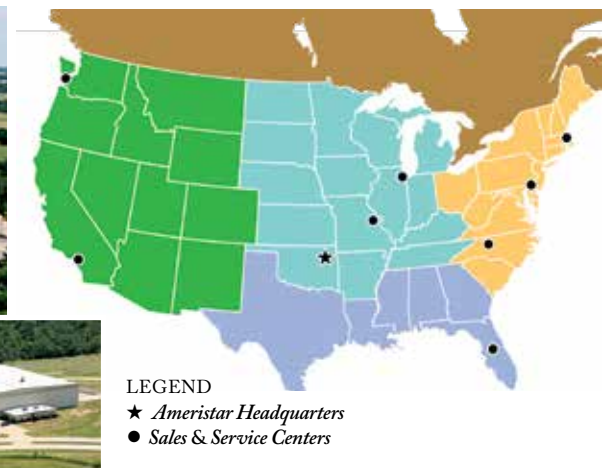

#1820-2002



AMERISTARFENCE.COM | 888-333-3422

Experience a safer and more open world

AMERISTAR[®]
ASSA ABLOY