

IMPASSE II[®]

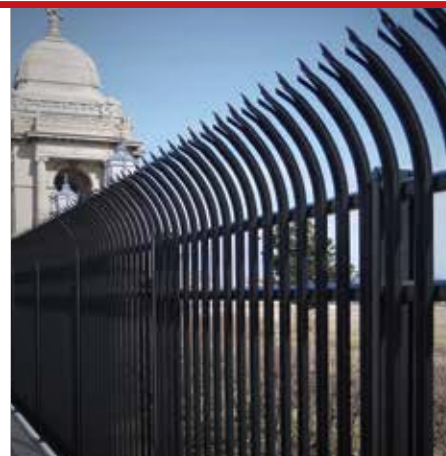

HIGH SECURITY STEEL PALISADE FENCING



AMERISTARFENCE.COM | 800-321-8724
Experience a safer and more open world

AMERISTAR[®]

ASSA ABLOY



AESTHETIC APPEAL. UNPARALLELED PROTECTION.

Traditional security fences of chain link or wire mesh *are no longer enough* to meet today's increased security demands. Ameristar's Impasse II security fence offers the *resistive strength* of heavy-duty *steel pales secured vertically* to a framework of *specially formed rails and I-beam posts*. The stylish design of the Impasse II, combined with its strength and security, *provides a successful first line of defense*.





Primary applications for Impasse II ornamental steel fence systems include:

- ▶ ***Military Sites***
- ▶ ***Government Facilities***
- ▶ ***Petroleum & Chemical Facilities***
- ▶ ***Power Plants & Substations***
- ▶ ***Airports***
- ▶ ***Data Centers***
- ▶ ***Ports of Entry***
- ▶ ***Water Treatment & Storage***

IMPASSE II[®]

HIGH SECURITY STEEL PALISADE FENCE

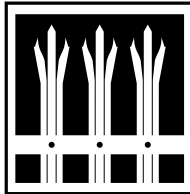

TRIDENT[™]

The Impasse Trident *pale rises above the topmost rail and terminates with a menacing triple-pointed splayed spear tip.* The intimidating look of the Trident corrugated pale is a *visual deterrent* to any who would dare to intrude.

- ▶ 3-RAIL PANELS | 6', 7', 8', 9' & 10' HEIGHTS
- ▶ 2-RAIL PANELS | 6', 7' & 8' HEIGHTS

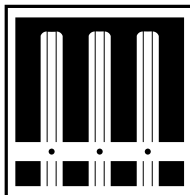

STRONGHOLD[™]

The *blunt, slightly rounded tip* of the Stronghold offers strength when necessary, while providing *safety and security to the general public.* The Stronghold features the *same structural configurations of its high-security counterparts.*

- ▶ 3-RAIL PANELS | 6', 7', 8', 9' & 10' HEIGHTS
- ▶ 2-RAIL PANELS | 6', 7' & 8' HEIGHTS

2.75"w x 14ga PALES | 2" x 2" x 11ga RAILS | 3" x 2.75" x 12ga & 4" x 2.75" x 11ga I-BEAM POSTS

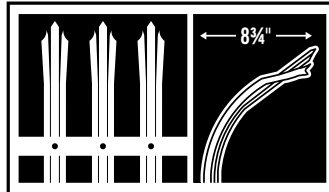

GAUNTLET™

Gauntlet is designed with *high-tensile steel corrugated pales that rise above the topmost rail with an outward curve* and terminate with a triple-pointed splayed spear tip. The outward curved pales *discourage attempts to gain access* by would be intruders.

- ▶ 3-RAIL PANELS | 7', 8', 9' & 10' HEIGHTS
- ▶ 2-RAIL PANELS | 7' & 8' HEIGHTS

ANTI-SCALE OPTION

The Impasse II *Anti-Scale fence system* has *decreased pale spacing*, which helps deter the assailant from climbing, and *increases the delay time when trying to cut or pry through the fence*.

COLOR OPTIONS



BLACK

BRONZE

SAND

WHITE

Custom colors also available





PERMACOAT™

Impasse II is protected by the unique PermaCoat process. Our **PRE-GALVANIZED STEEL BASE MATERIAL** is subjected to an **11-STAGE PROCESS** to cleanse & prepare the steel for a **DUAL TOP-COAT FINISH**. PermaCoat's corrosion resistant abilities far surpass those of painted surfaces and have a "no-mar" polyester powder top coat. This dual coating not only provides **RESISTANCE FROM WEATHERING** but also reduces scratch & burnishing marks typically encountered during shipping.

PRE-TREATMENT

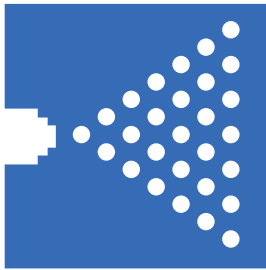

ALKALINE WASH

Cleans metal for proper adhesion of zinc phosphate

1

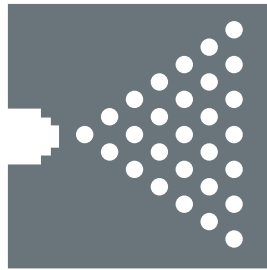

FIXIDINE RINSE

Rinses excess alkaline prior to zinc phosphate application

2

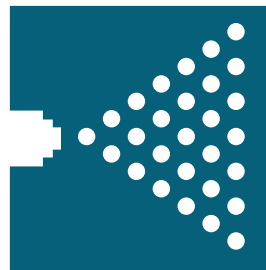

PHOSPHATE RINSE

Corrosion resistant layer that assists in bonding powder coating

3

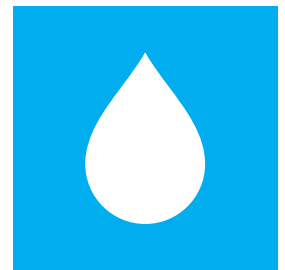

CLEAR WATER RINSE

A bit of clean H2O to prep for the next phase

4

DOUBLECOATING

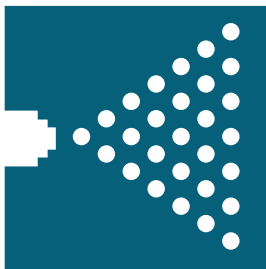

EPOXY POWDER COAT

Epoxy powder is electrostatically applied

8



EPOXY GEL OVEN

Powder is gelled & cured to finish coat

9

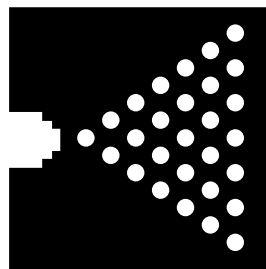

POLYESTER POWDER

TGIC powder is electro-statically applied

10



FINISH CURING OVEN

Seals finish for years of maintenance free use

11

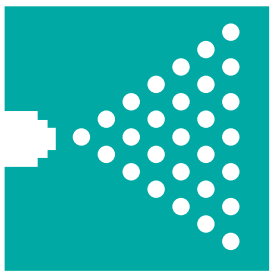

NON-CHROMATE SEAL

Barrier to prevent moisture from reaching base metal

5



CLEAR WATER RINSE

Final wash in H2O to remove any excess debris or particles

6



DRYING OVEN

Eliminates all moisture prior to double coating

7

ONCE COMPLETED, THESE 7-STAGES WILL HAVE REMOVED EVERYTHING FROM THE SURFACE OF THE STEEL THAT MIGHT INHIBIT THE FINISH FROM PROPERLY ADHERING DURING THE NEXT 4-STAGES OF THE COATING PROCESS.

CORROSION TESTING

Corrosion occurs more easily without the proper preparation & protection, which is why Ameristar has put our fence products to the test based on ASTM B117 standards. *The results speak for themselves.*



PAINTED STEEL



PRIMED & PAINTED STEEL



SINGLE COAT PROCESS
Iron Phosphate + Polyester Powder Coat



SINGLE COAT PROCESS
Zinc Phosphate + Polyester Powder Coat



PERMACOAT PROCESS
Zinc Phosphate + Epoxy Powder Coat + Polyester Powder Coat

IMPASSABLE DESIGN

Impasse II panels and posts are manufactured using **HIGH-TENSILE PRE-GALVANIZED G-90 STEEL**. Each component has been **ROLL-FORMED** into a unique profile that yields significant strength properties. Impasse II's distinct design enables the fence to **TRAVERSE AGGRESSIVE CHANGES IN GRADE IN ORDER TO MAINTAIN SECURITY** along any perimeter. Each connection point of the Impasse II system is secured with **TAMPER-PROOF FASTENERS** providing the **HIGHEST LEVEL OF SECURITY & VERSATILITY**.

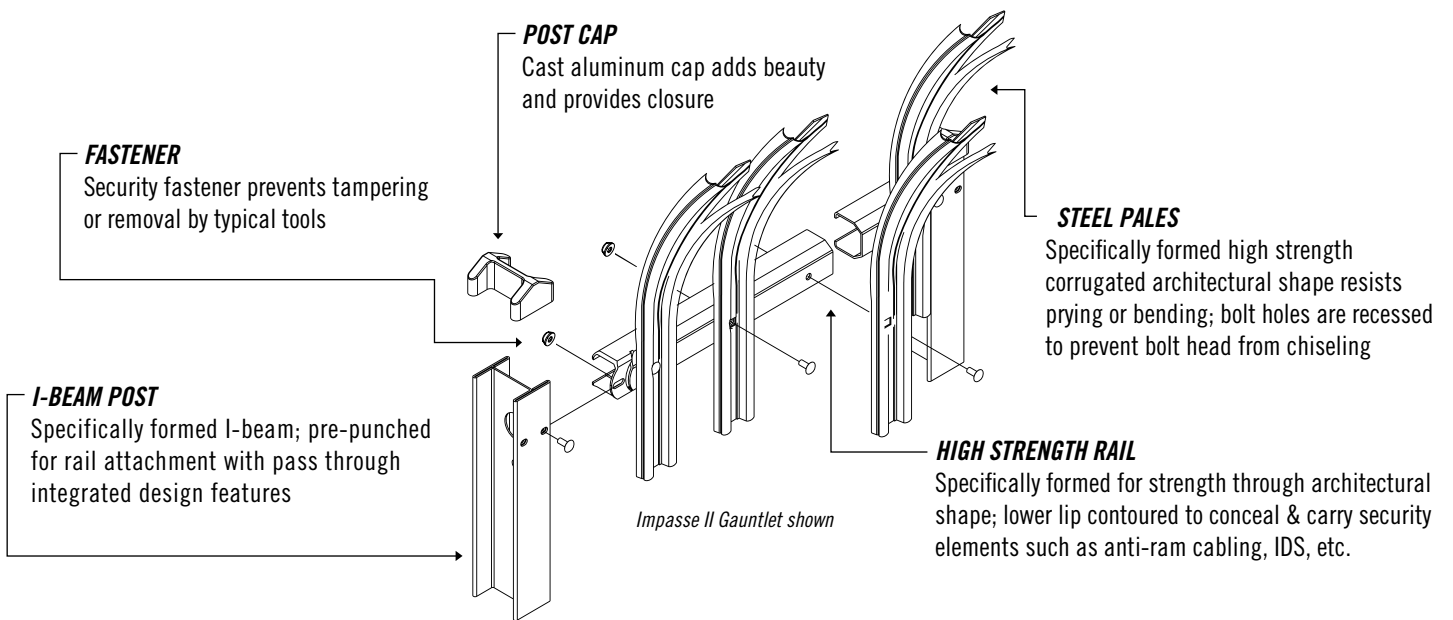

PRIVACY SCREENING OPTION

A security fence should cover multiple aspects of perimeter security, which is why Ameristar created the steel privacy screening option for its Impasse high security fence system. Secured by each adjacent pale, the overlapping design achieves the maximum level of opacity for visual screening.



Certified by the US Department of Homeland Security as a method of risk management against acts of terrorism



Ameristar's Impasse II is backed by over 30 years of excellence in the fencing industry



Ameristar is committed to providing products that meet the Buy American Act



Ameristar products have the opportunity to earn LEED points

RAKEABLE VS STAIR-STEP

Biasability at a minimum of 25% that requires no additional assembly. This unique feature eliminates unsightly stair-stepping panels.

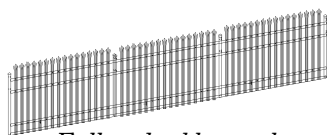

Fully rakeable panels

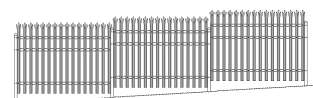

Stair-stepping panels

DESIGN INTEGRATION

The Impasse II framework is a raceway for wiring, conduits & security cabling required around the perimeter of a project. This integrated design eliminates the need for costly trenching & boring becoming a value added solution for perimeter security upgrades.



(inside of rail shown above / view from protected side)

When installing these security elements use Impasse II as a platform:

- **Communication & Video Cables**
- **Intrusion Detection / Fiber Optic Cables**
- **Access Control Wiring**
- **Conduits**
- **Anti-Ram Cabling (Stalwart IS)**

STALWART IS[®]

ANTI-RAM BARRIER + SECURITY FENCE

Stalwart IS unites the *strongest security fence available* with the *most widely used anti-ram perimeter barrier*. The appearance of Stalwart IS is a great *visual deterrent* that delivers strength and fortitude for keeping any assailant from easily breaching the perimeter.

M50 M40 M30

PU60 PU50 K12 K8 K4

Stalwart IS offers *multiple anti-ram ratings*. Each installation can be designed with the most appropriate standoff distance from the asset.



ARCHITECTURAL SUPPORT & SOLUTION SPECIALISTS



Ameristar's *Project Solution Specialists* are *experienced in every facet of perimeter security design*. Our goal is to assist the architectural community in finding the *best perimeter & entry solutions* for their projects. Ameristar's extensive library of project photos, CAD drawings, architectural specifications & project budget quotes are just a few of the services *our team offers to complete your project design*.

SLIDE GATES & SWING GATES

Egress & ingress requirements are unique to each application. *Managing traffic flow & usage demands* are of the utmost importance, which is why Impasse II is manufactured in a variety of gate types built to *balance function, security & beauty*.

Ameristar *Transport™* & *Passport™* sliding gates perfectly match the perimeter fence system to create a *seamless & stunning design* while exuding a *commanding presence* of security built to unite perimeter and entry.



WHY CHOOSE AMERISTAR

▶ KNOWLEDGE & EXPERIENCE

Ameristar was chartered over *30 years ago* in response to the *demand by consumers & specifiers for specialty fence products*. Ameristar offers an *aesthetically pleasing product* that is both *high in quality & affordability*. This has been achieved by maximizing *high-volume productivity*, increasing product design strength, and promoting *simplistic installation*.

▶ PROVEN CAPABILITY

Ameristar's integrated *in-house process & extensive raw material inventory* results in much improved productivity and availability compared to the competition. By having a *vast finished goods inventory*, Ameristar is capable of *delivering finished products faster* than competitors who sublet the majority of their operations.

▶ INDUSTRY LEADERSHIP

Over the years Ameristar has continually *raised the bar* across the board in the *manufacturing of high quality*, innovative fencing products. Our demonstrated commitment to *upholding higher values* translates into superior products that *go far beyond* merely meeting minimum industry standards.



Ameristar's world headquarters, manufacturing & coil processing facilities in Tulsa, Oklahoma, USA.

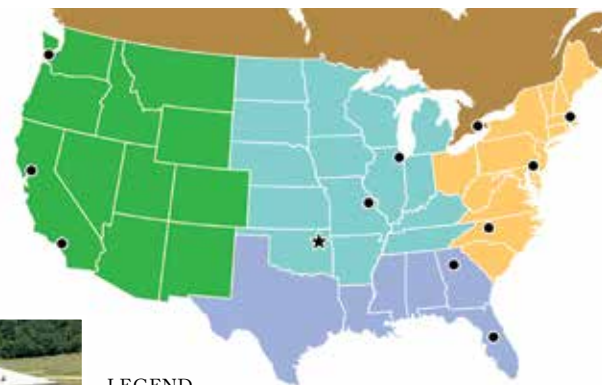

LEGEND

- ★ Ameristar Headquarters
- Sales & Service Centers

#9718 | REVISED 10/2021



AMERISTARFENCE.COM | 800-321-8724

Experience a safer and more open world

AMERISTAR[®]

ASSA ABLOY